



# ***User Manual***

## **Outdoor HD IP Camera**



Model: SABIP1300

## Table of Contents

---

Table of Contents.....	1
1 Overviews.....	2
1.1 Key Features.....	3
1.2 Read Before Use.....	3
1.3 Packing Contents.....	4
1.4 Physical Description.....	4
1.4.1 Front Panel.....	4
1.4.2 Interface.....	4
1.4.3 Bottom View.....	5
1.5 Wall installation.....	5
2 Access the IP Camera.....	5
2.1 Hardware Connection & Software Installation.....	6
2.2 Access the Camera in LAN.....	6
Wired connection.....	6
2.3 Access the Camera in WAN.....	7
2.3.1 Static IP Addresses.....	7
2.3.2 Remote Access.....	8
2.4 Using the VLC player.....	11
2.5 IP camera connection to the server.....	13
3 Surveillance Software GUI.....	14
3.1 Login Window.....	14
3.2 Surveillance Window.....	15
4 Advanced Camera Settings.....	21
4.1 Device Status.....	21
4.1.1 Device Information.....	21
4.1.2 Device Status.....	22
4.1.3 Session status.....	22
4.1.4 Log.....	22
4.2 Basic Settings.....	23
4.2.1 Camera Name.....	23
4.2.2 Camera Time.....	23
4.2.3 User Accounts.....	24
4.2.4 Multi-Camera.....	26
4.3 Network.....	30
4.3.1 IP Configuration.....	30
4.3.2 DDNS.....	32
4.3.3 UPnP.....	36
4.3.4 Port.....	36
4.3.5 Mail Settings.....	38
4.3.6 FTP Settings.....	39
4.3.7 P2P.....	41
4.4 Video.....	41

- 4.4.1 Video Settings..... 41
- 4.4.2 On Screen Display.....42
- 4.4.3 Privacy Zone.....43
- 4.4.4 Snapshot Settings.....44
- 4.4.5 IR LED Schedule..... 45
- 4.4.6 Lens Distortion Correction.....45
- 4.5 Alarm.....46
  - Motion Detection..... 46
- 4.6 Record.....49
  - 4.6.1 Storage Location.....49
  - 4.6.2 Local Alarm Location.....49
- 4.7 Firewall.....49
- 4.8 System..... 50
  - 4.8.1 Back-up& Restore.....50
  - 4.8.2 System Upgrade..... 51
  - 4.8.3 Factory Reset.....53
  - 4.8.4 Reboot.....53
- 5 Appendix.....53
  - 5.1 Frequently Asked Questions..... 53
    - 5.1.1 Install the ActiveX of Firefox browser, Google Chrome and IE Chrome..... 53
    - 5.1.2 Uninstall the ActiveX of Firefox browser, Google Chrome and IE Chrome..... 56
    - 5.1.3 I have forgotten the administrator password.....58
    - 5.1.4 Subnet doesn't match..... 58
    - 5.1.5 Camera can not record..... 58
    - 5.1.6 No Pictures Problems..... 58
    - 5.1.7 Can't access IP camera in internet.....59
    - 5.1.8 UPnP always failed.....60
  - 5.2 Default Parameters..... 60
  - 5.3 Specification..... 60
  - 5.4 CE & FCC..... 61

# 1 Overviews

Outdoor HD IP Camera is an integrated IP Camera with a color CMOS sensor enabling viewing in High Definition resolution. It combines a high quality digital video camera, with a powerful web server, to bring clear video to your desktop from anywhere on your local network or over the Internet.

The IP Camera supports the industry-standard H.264 compression technology, drastically reducing file sizes and conserving valuable network bandwidth.

The IP Camera is based on the TCP/IP standard. There is a WEB server inside which could support Internet Explorer. Therefore the management and maintenance of your device is simplified by using the network to achieve the remote configuration and start-up.

The camera is designed for outdoor surveillance applications such as courtyards, supermarket, and school. Controlling the IPCAM and managing images are simplified by using the provided web interface across the network utilizing connectivity.

We provides Phone APPs for Android and iPhone users, please search and install App on App Store and Google Play for iOS and Android devices, then you can view your camera anywhere, anytime on your smart mobile devices.

## 1.1 Key Features

- ◆ Standard H.264 video compression algorithm to satisfy the transmission of high definition video in narrow bandwidth network
- ◆ 2.0 Mega-Pixel Supports IE/Firefox/Google/Safari browser or any other standard browsers
- ◆ Supports WEP,WPA and WPA2 Encryption
- ◆ IR night vision, Range:30m
- ◆ Supports image snapshot
- ◆ Supports dual-stream
- ◆ Supports IR-Cut and the filter change automatically
- ◆ Embedded DDNS(dynamic domain name service) Service
- ◆ Supports remote viewing & record from anywhere anytime
- ◆ Multi-level users management with password protection
- ◆ Motion detection alert via email
- ◆ Supporting Third Party Domain name
- ◆ Providing Phone APPs for Android and iPhone users
- ◆ Supports multiple network protocols: HTTP /HTTPS/ RTSP/ TCP /IP /UDP /FTP /DHCP /DDNS /UPNP/ONVIF
- ◆ Providing Central Management Software to manage or monitor multi-cameras

## 1.2 Read Before Use

Please first verify that all contents received are complete according to the Package Contents listed below. Before the Network Camera is installed, please carefully read and follow the instructions in the Quick

Installation Guide to avoid damage due to faulty assembly and installation. This also ensures the product is used properly as intended.

### 1.3 Packing Contents

● IPCAM×1	● CD×1
● DC Power Supply×1	● Quick Installation Guide ×1
● Mounting bracket×1	● Network Cable×1

### 1.4 Physical Description

#### 1.4.1 Front Panel

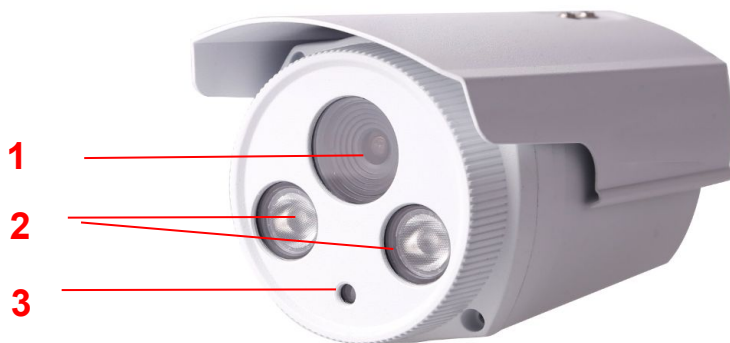

Figure 1.1

- 1 **LENS:** CMOS sensor with fixed focus lens
- 2 **Infrared Lamp Array**
- 3 **Induction IC**

#### 1.4.2 Interface



Figure 1.2

1 LAN

10/100M adaptive Ethernet interface. Through this interface, IPCAM can be connected with various network devices, such as hub, router, etc.

## 2 Reset button

Press and hold on the reset button for 5 seconds. Releasing the reset button, the password will back to the factory default administrator password. The default administrator user is admin with no password.

## 3 Power Interface

Connect the external power adapter, request for 12V/2A or 12V/1A power.

## 1.4.3 Bottom View

There are up to two labels located at the bottom of the camera, this is an important feature of original cameras. If your camera does not have labels, it may be a clone. Cloned cameras can not use original firmware and are not eligible for warranty or technical services.

## 1.5 Wall installation

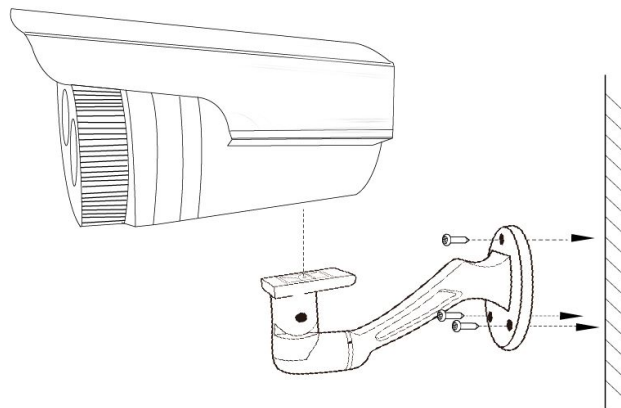

Figure 1.3

Step 1: Screw the mount on the wall with the 3 screws provided.

Step 2: Install the camera on the mounting bracket with 1 screw to complete installation.

### NOTE:

Ensure that the rain or water will not reach the connector ports at the end of the pig tail wiring. These connectors are not weather-resistant.

## 2 Access the IP Camera

## 2.1 Hardware Connection & Software Installation

1. Connect the camera to the LAN network (Router or Switch) via network cable.
2. Connect the power adapter to the camera.
3. Insert the CD into the CD drive of your computer.
4. Go to the folder "Equipment Search Tool" and find the folder "For Windows OS" or "For Mac OS". Copy and paste the search tool file to your computer, or drag it onto your Desktop.



Shortcut icon for Windows / Mac OS

### Notes:

- If your computer ( Windows OS ) supports autorun function, you can find the corresponding file in the opened control panel.
- If your computer doesn't have CD drive, you can download the Equipment Search Tool from our website for free.

## 2.2 Access the Camera in LAN

### Wired connection

The camera supports HTTP and HTTPS protocols, you can access the camera in two ways.

#### (1) Http:// LAN IP + Http Port No.

The default HTTP port NO. is 88. Double click the Equipment Search Tool icon to run, and it should find the camera's IP address automatically after you plug in the network cable.

Camera Name	IP Address	Device ID	Type
Anonymous	Http://192.168.1.105:88	00626E55AB1E	IPC

Figure 2.2

Double click the IP address of the camera; the camera login page should be open in your default browser.

#### (2) Https:// LAN IP + Https Port no.

The default HTTPS port NO. is 443. You can use the URL to access the camera: https:// LAN IP + HTTPS port NO.

Go to **Settings - Network - Port** panel, you can see and change the HTTP and HTTPS port NO.

Save Refresh	
HTTP Port	<input type="text" value="88"/>
HTTPS Port	<input type="text" value="443"/>
ONVIF Port	<input type="text" value="65533"/>

Figure 2.3

**NOTE:**

When logging in for the first time, you will need to download and install the add-on.

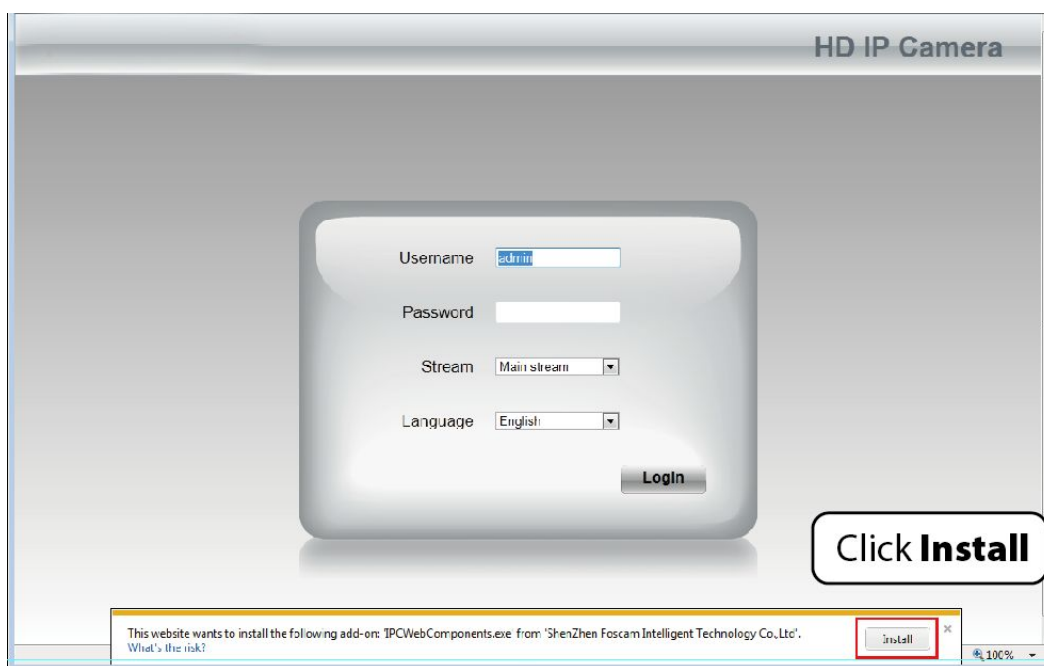

Figure 2.4

## 2.3 Access the Camera in WAN

### 2.3.1 Static IP Addresses

Users who have static IP addresses do not need to set DDNS service settings for remote access. When you have finished connecting the camera using the LAN IP address and port forwarding, you can access the camera directly from the Internet using the WAN IP address and port number.

#### How to Obtain the WAN IP address from a public website ?

To obtain your WAN IP address, enter the following URL in your browser: <http://www.whatismyip.com>. The webpage at this address will show you the current WAN IP.





Figure 2.5

## Access your IP Camera from the Internet

You can access the IP Camera from the Internet (remote access). Enter the WAN IP address and port number in your standard browser. For example, you would enter `http:// 183.37.28.254:88`

### 2.3.2 Remote Access

If you want to access your camera by web browser outside of your LAN, you need to configure following configurations.

1. Choose “Settings” on the top of the camera web page, then go to the “Network > IP Configuration” section on the left side of the screen, then uncheck the Obtain IP DHCP.

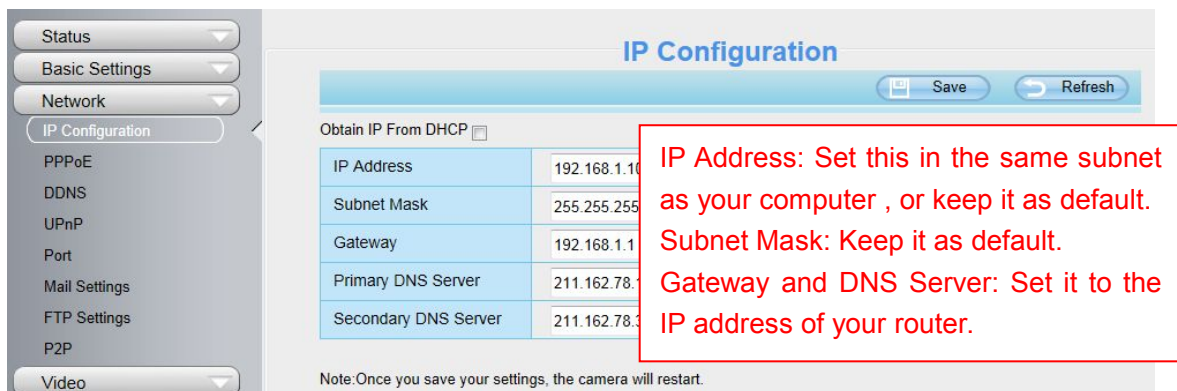

Figure 2.6

2. Enable UPnP and DDNS in the camera’s settings page. We recommend you to use the DDNS by factory default.

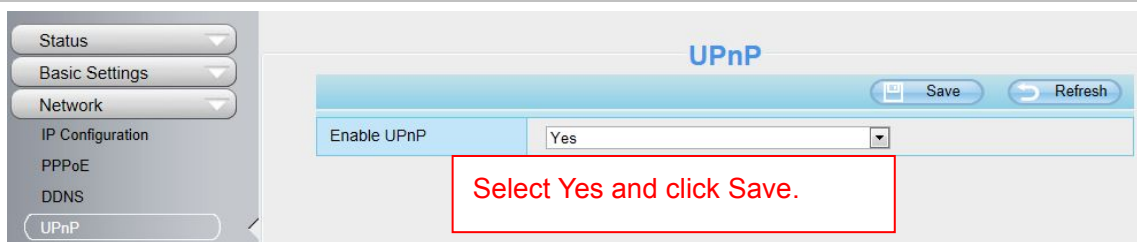

Figure 2.7

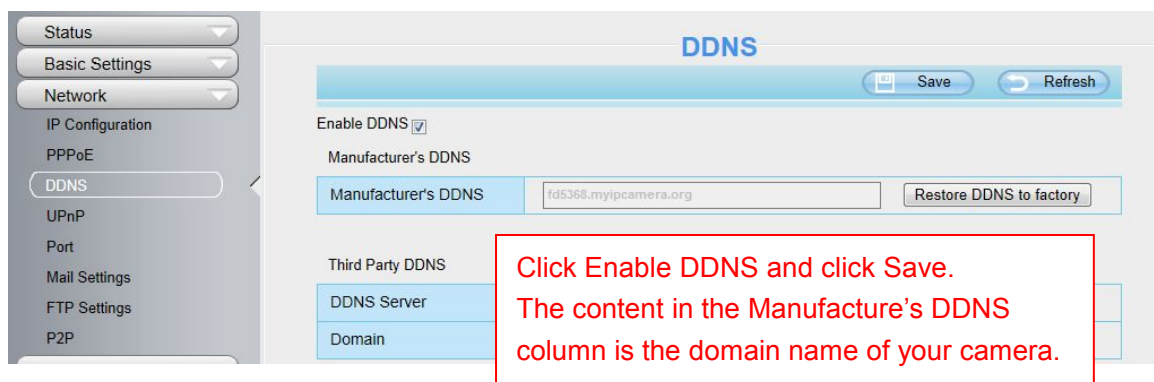

Figure 2.8

3. You can see the port of your camera here. If you want to set Remote Access for several cameras on the same network, you will need to change the HTTPS port for each camera.

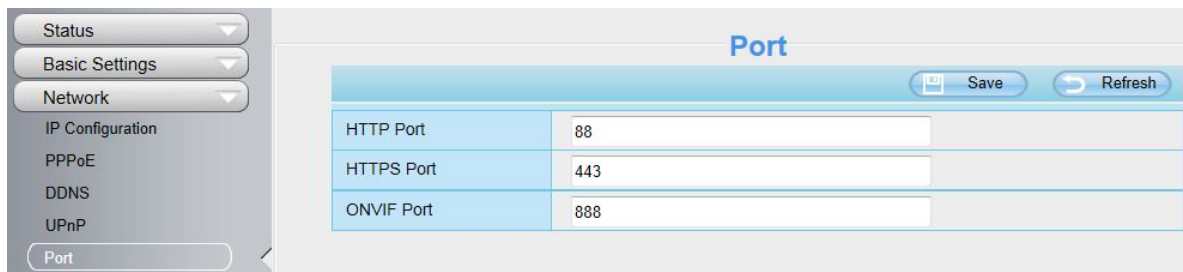

Figure 2.9

4. If the UPNP of the router has been enable, you do not need to perform following steps. Otherwise, you need to select one of the following methods to configure port forwarding on your router. For these steps, we will be using the TP-LINK brand wireless router as an example.

- **If there is a UPNP function in your router:**

Choose "Forwarding > UPNP", make sure that the Current UPNP Status is Enabled.

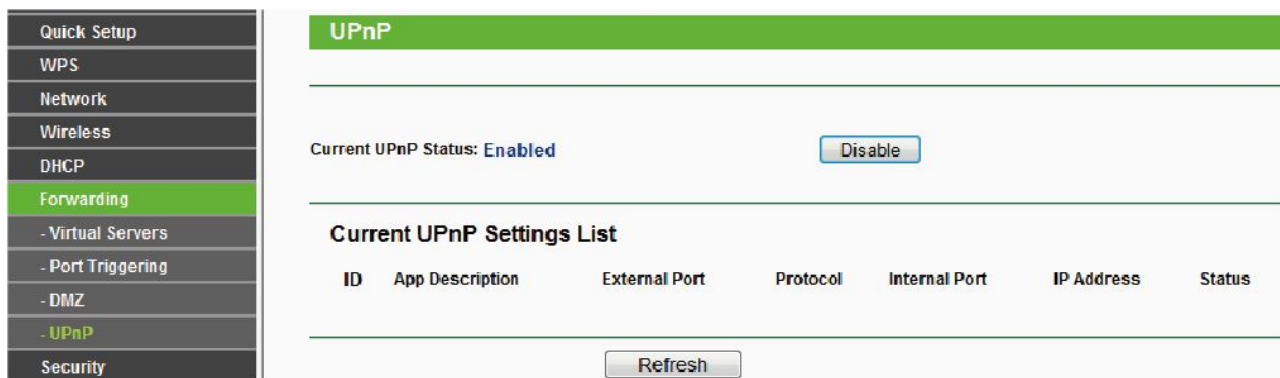

Figure 2.10

● **If there is no UPnP function in your router:**

You need to manually add port(HTTPS port) forwarding, refer to the following steps. You need go to the “Forwarding > Virtual Servers” panel for setup.

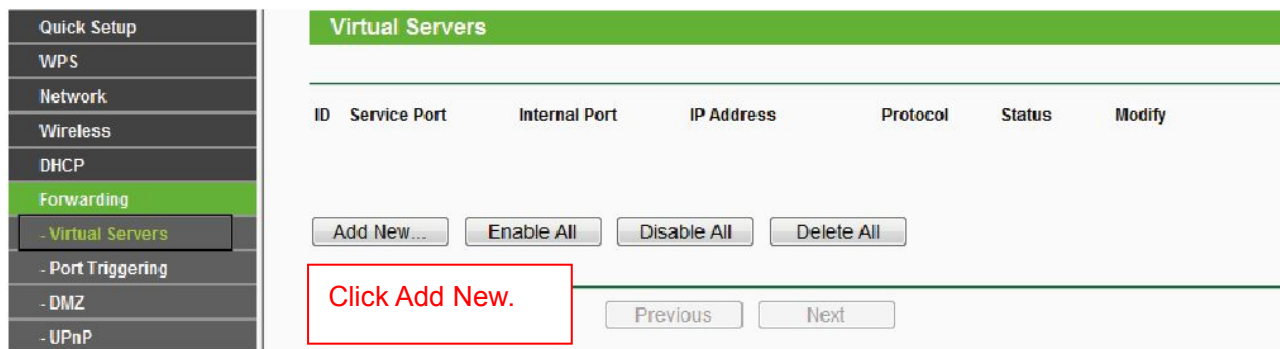

Figure 2.11

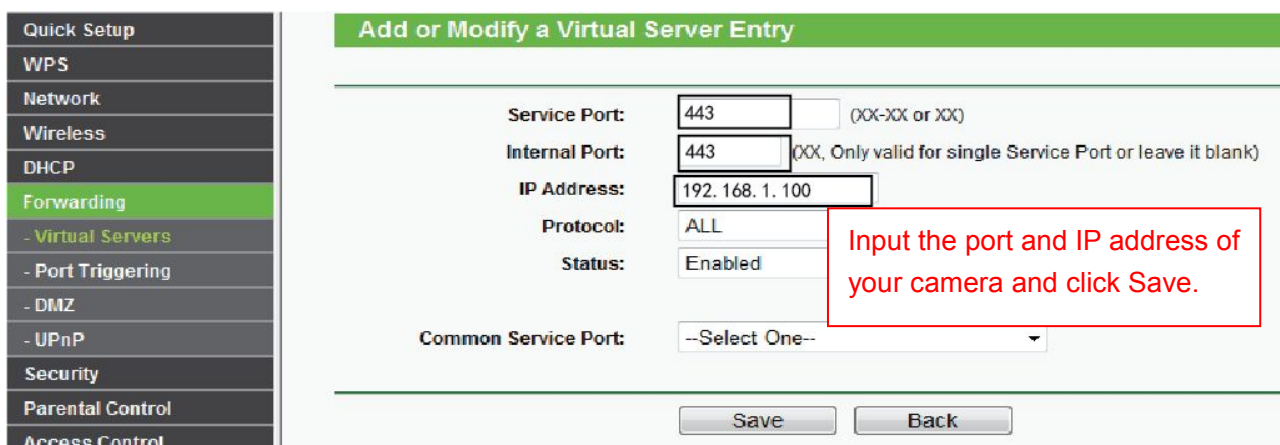

Figure 2.12



Figure 2.13

5. Now you can access your IP camera by <https://domain name: HTTPS port via the Internet>.

## 2.4 Using the VLC player

This camera supports RTSP streaming, here you can view the camera using VLC player.

**RTSP URL** [rtsp:// \[user name\]:\[password\]@IP:port number/videosream](rtsp://[user name]:[password]@IP:port number/videosream)

The part in the square brackets may be omitted.

**user name & password:**

The user name and password to access the camera. This part can be omitted.

**IP:** WAN or LAN IP address.

**port number:** If there is the RSTP port number on the Port page, you must only use RTSP port number. otherwise, you must only use http port number.

**Videostream:** Here support three modes: videoMain, videoSub and audio. When the network speed is bad, here you had better select videoSub. If you select audio, you can only hear the sound but cannot see the video.

**For example:**

IP: 192.168.1.11

Port number: 88

User name: admin

Password: 123

Here I can enter one of the following URLs in the VLC.

1. <rtsp://admin:123@192.168.1.11:88/videoMain>
2. [rtsp:// @192.168.1.11:88/videoMain](rtsp://@192.168.1.11:88/videoMain)
3. <rtsp://:123@192.168.1.11:88/videoMain>
4. <rtsp://admin@192.168.1.11:88/videoMain>

Open the VLC, and go to Media(Open Network Stream option, then enter the URL into VLC.

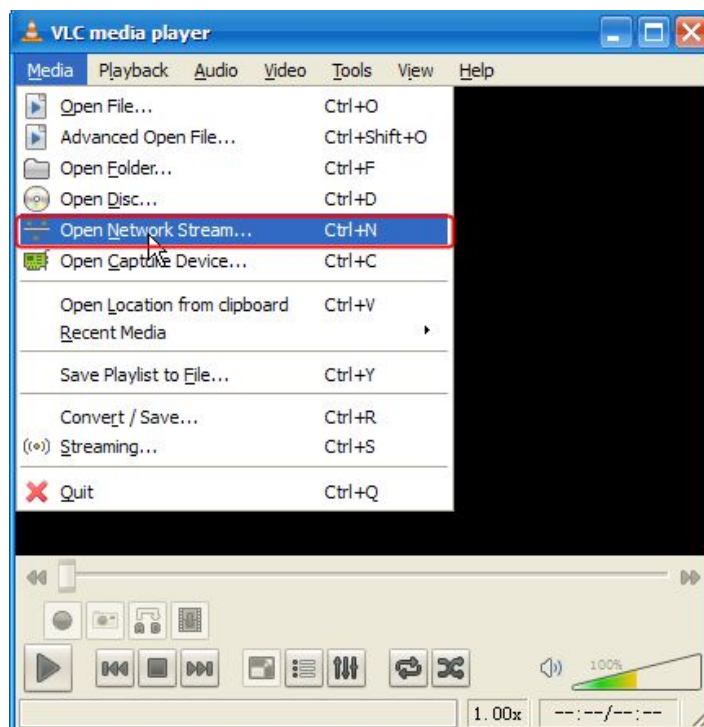

Figure 2.14

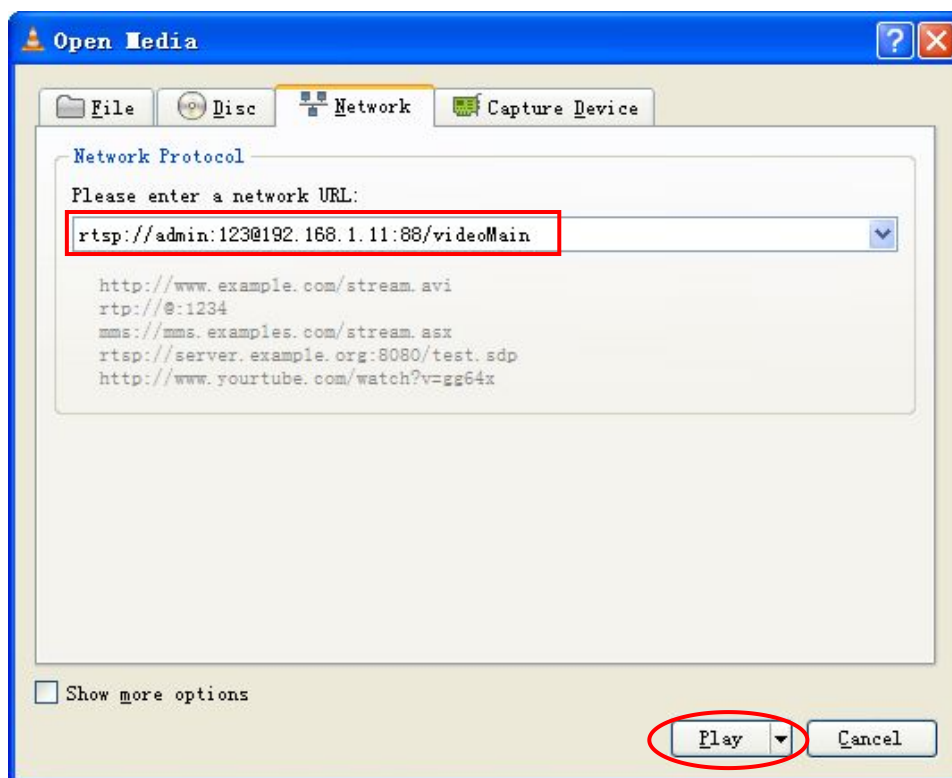

Figure 2.15

Sometimes you may need to enter the user name and password again. Click OK and you can see the real-time preview.



Figure 2.16

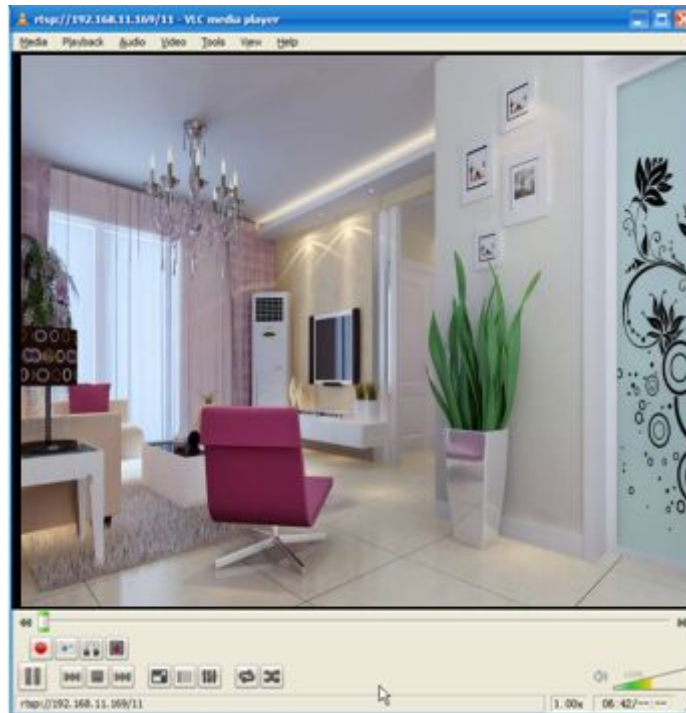

Figure 2.17

If you cannot play the video in the VLC player, please check the port mapping. You can read Quick Installation Guide about How to configure port forwarding.

**NOTE:**

If you modify the camera's username or password, you had better reboot the camera, or else the new username and password cannot take effect when you enter the authentication in the VLC.

## 2.5 IP camera connection to the server

Device supports ONVIF 2.2.1 protocol, You can easily access the NVR with ONVIF or server with ONVIF.

## 3 Surveillance Software GUI

Please refer to the section 2.1 if you install the camera for the first time. You can start to learn about software operation after finish quick installation.

### 3.1 Login Window

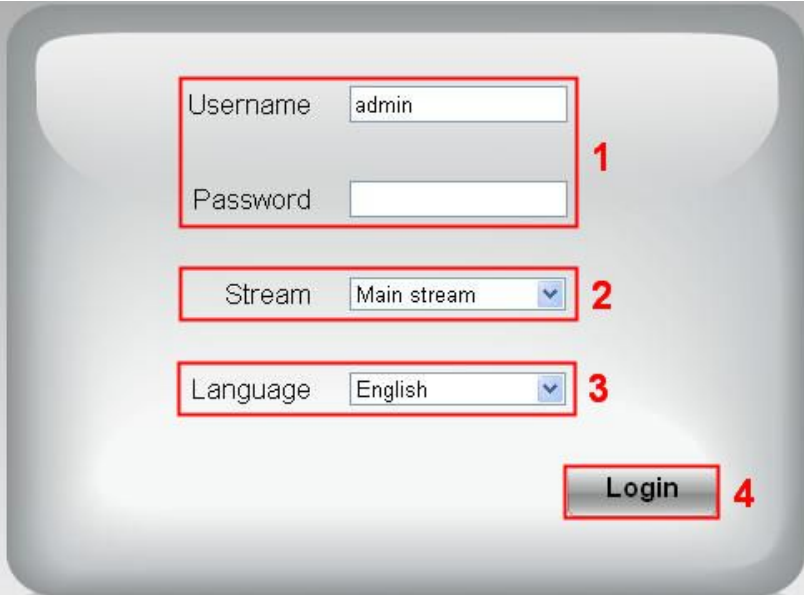

The screenshot shows a login window with the following elements:

- 1**: Username field containing 'admin' and an empty Password field.
- 2**: Stream dropdown menu set to 'Main stream'.
- 3**: Language dropdown menu set to 'English'.
- 4**: Login button.

Figure 3.1

#### **Section1** Enter the Username and password

The default administrator username is admin with no password, please change the password at first using and prevent unauthorized users login the camera.

#### **Section2** Stream

The camera supports two stream modes: Main stream and sub stream. If you want to access the camera form LAN, here you can select Main stream. If you want to access the camera from Internet, here we recommend sub stream.

**Note:** When the network bandwidth is bad you'd better select Sub Stream and the video will be more fluent.

#### **Section3** Select the language

You can select the language you need by clicking on the language dropdown list.

#### **Section4** login the camera

Click "Login" button.

#### **NOTE:**

When setting up your camera for the first time, it will request that you modify the default username and/or password if both are still set to default. Input the new username and password, click "Modify" to complete the

modification. You will now use the new username and password to login the camera in the future.

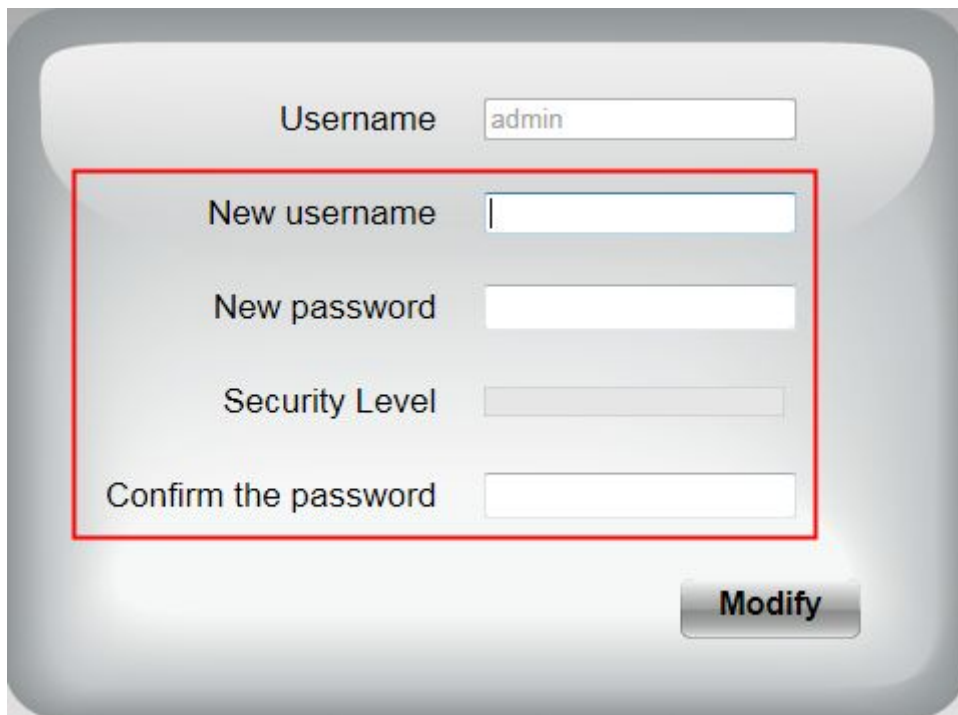

Figure 3.2

### 3.2 Surveillance Window

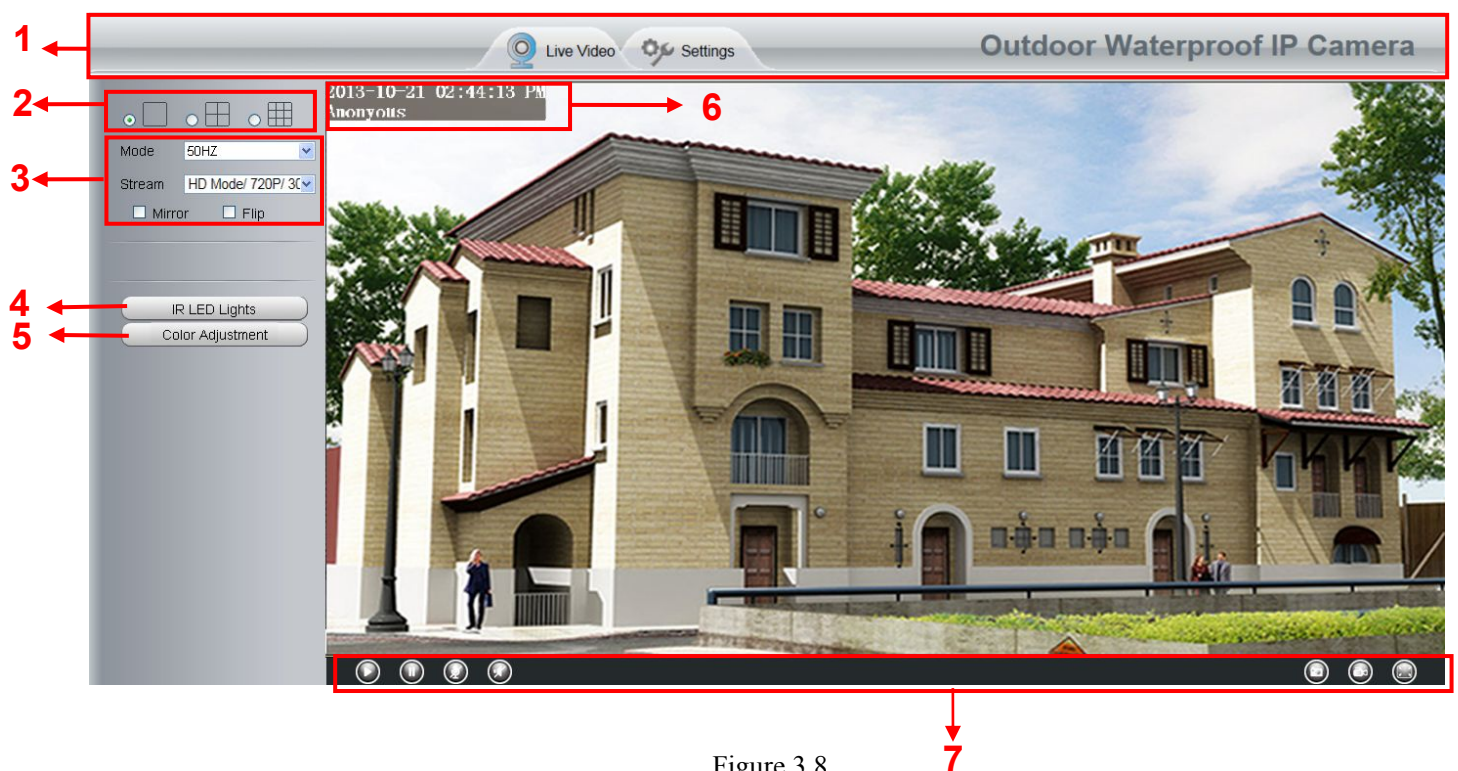

Figure 3.8



### Section1 LiveVideo / Settings buttons



: Path to surveillance window. Click this button and back to the surveillance window



: Path to Administrator Control Panel, Click it, and it will lead to Administrator Control Panel and do advanced settings.

### Section2 Multi-Device Window



The firmware inside the camera supports up to maximum of 9 cameras being monitoring at the same time. You can add other cameras in multi-camera panel.

### Section3 Mode/ Stream / Mirror/ Flip buttons

#### Mode

- 1) 50Hz -----Indoor surveillance (Region: Europe, China)
- 2) 60Hz -----Indoor surveillance (Region: USA, Canada)
- 3) Outdoor Mode-----Outdoor surveillance

#### Stream

The default stream supports multiple modes, For example: HD Mode/720P/30fps/2M meanings: **Stream type / Resolution / Maximum frame rate/ Bit rate**. (Different models support different specific mode. )

1) **Stream type no.** : Identify the stream type.

#### 2) Resolution

The bigger the resolution, the better of the image quality is. If you are accessing the camera via internet and want to get more fluent video streaming, please select resolution VGA.

#### 3) Maximum frame rate

The maximum frame rate is 30 fps. You should lower frame rate when the bandwidth is limited. Normally, when the frame rate above 15, you can achieve fluently video. The maximum frame rate for each model is different, please see the “**Specifications**” .

#### 4) Bit rate

Generally speaking, the larger the bit rate is, the clearer video will become. But the bit rate configuration should combine well with the network bandwidth. When the bandwidth is very narrow, and bit rate is large, that will lead to video cannot play well.

You can reset the stream type on “**Settings-> Video-> Video Settings**” panel.

### How to do cruise?

**Firstly:** Select one track in the track drop-down list



**Secondly:** Click Start cruise button, the camera will cruise following the predefined path.

**Thirdly:** Click stop button and finish cruising.

#### Section4 IR LED Lights

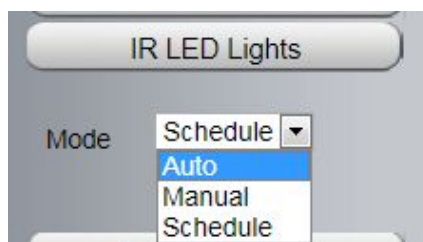

Click Infra led and there are three modes to adjust the infrared led: Auto, Manual and Schedule.

**Auto:** Select it and the camera will adjust the infra led (on or off) automatically.

**Manual:** Select it and turn off the infra led manually.

**Schedule:** Select it and the IR led light will be off at the schedule period. If you want to define or change the IR led lights schedule time, please go to **Settings**→**Video**→**IR LED Schedule** page.

#### Section5 Image quality settings

In this page, you can tune Hue, Brightness, Contrast, Saturation, and Sharpness to get higher quality.



#### Section6 OSD

If you have added time and camera name in the video, you can see it in the live window.

Go to **Settings** ---**Basic settings**---**Camera name** panel, and you can change another device name. The default device name is anonymous.

Go to **Settings** ---**Basic settings**---**Camera time** panel and adjust the device time.

Go to **Settings** ---**Video**---**On Screen Display** panel, you can add or no add OSD.

#### Section7 Play/Stop/ Talk/Audio/ Snap/ Record/ Full screen button

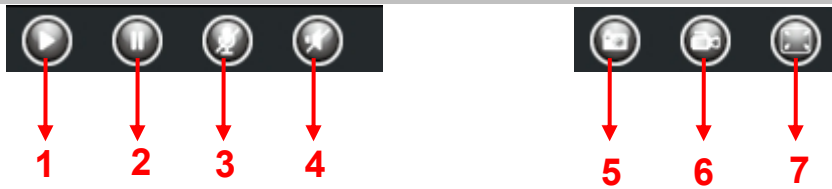

- 1-----**Play** Click it to play the video of the camera
- 2-----**Stop** Click it to stop the video of the camera

3----- **Talk:** Click the button and the icon will become to , then talk to the microphone that connected with PC, people around the camera can hear your voice if the camera has connected with audio output device. Click the icon again and stop talking.

4----- **Audio** Click the button and the icon will become to , you can hear the sound around the camera if the camera has connected with other audio input device through the Audio Input port of the camera, Click the icon again and stop audio.

5----- **Snap:** Click it to make snapshot and it pop up a window which picture you snapshot, right click in the window and save the picture to anywhere you want.

6----- **Record:** Click the icon  and the camera start recording, you can see a green dot in the live window. Click again and stop recording. The default storage path is C:\IPCamRecord. You can change the storage path: Go to Settings- >Record-> Storage Location panel.

7-----**Full Screen** Click it to make full-screen, or you can double click the surveillance screen to make full-screen. Double click again and exit full-screen.

## Onscreen Mouse Control

Right click the mouse and you can adjust the screen ration, full screen and Zoom up.



Figure 3.9

Keep ration: Select it and the camera will adjust the size of live window based on the computer monitor

automatically.

Sometimes there is a black border around the video, please select Keep ration to get a better visual quality.



Figure 3.10

**Full Screen:** Select it and Click it to make full-screen, press ESC and exit full-screen.

**Zoom up/down:** Click it and the live view will be digital zoomed up, then click Zoom Down and the live view back to original size.



Figure 3.11

**NOTES:**

- 1 This camera don't support Pan/Tilt function, so here can't allow to use Screen PTZ.
- 2 For Mac OS, the plugin cannot support Onscreen Mouse function, so you cannot allow to use it.

## 4 Advanced Camera Settings

Click the button “Settings”, goes to Administrator Control Panel to make advanced camera settings.

### 4.1 Device Status

Device Status contains four columns: Device Information, Device Status, Session Status and Log, it will show you various information about your camera.

#### 4.1.1 Device Information



Refresh	
Camera Model	anonymous
Camera Name	anonymous
Camera ID	00841F19804W
Camera Time	2013/10/21 16:12:07
System Firmware Version	1.4.1.7
Application Firmware Version	1.14.1.20
Plug-In Version	2.0.1.6

Figure 4.1

**Camera Model:** The model of the device.

**Camera Name:** The Device Name is a unique name that you can give to your device to help you identify it. Click Basic Settings and go to Device Name panel where you can change your camera name. The default device name is anonymous.

**Camera ID:** Display the MAC address of your camera. For example Device ID is 008414350787, the same MAC ID sticker is found at the bottom of the camera.

**Camera Time:** The system time of the device. Click Basic Settings and go to Camera Time panel and adjust the time.

**System Firmware Version:** Display the System Firmware version of your camera.

**Application Firmware Version:** Display the application firmware version of your camera.

**Plug-In Version:** Display the plug-in version of your camera

## 4.1.2 Device Status

On this page you can see device status such as Alarm status, NTP/DDNS status, WIFI status and so on.

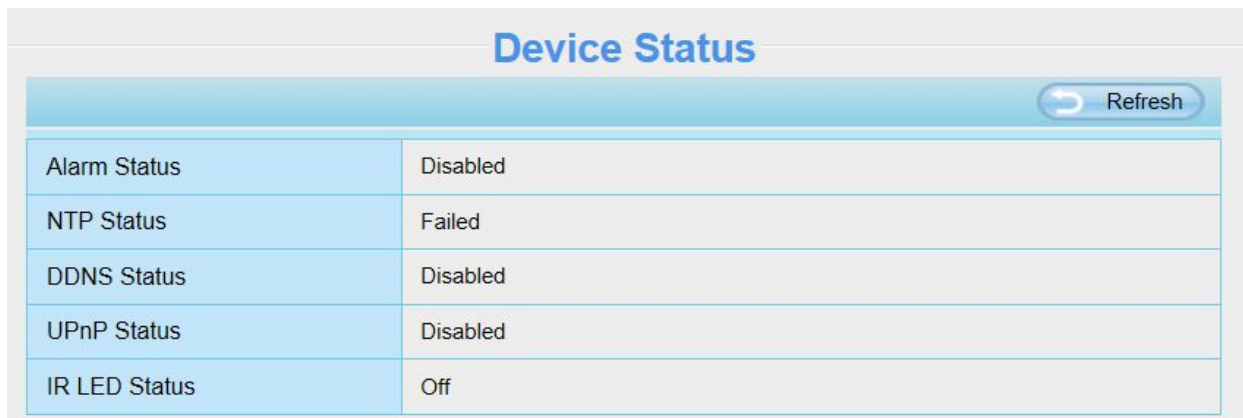

Device Status	
Alarm Status	Disabled
NTP Status	Failed
DDNS Status	Disabled
UPnP Status	Disabled
IR LED Status	Off

Figure 4.2

## 4.1.3 Session status

Session status will display who and which IP is visiting the camera now.

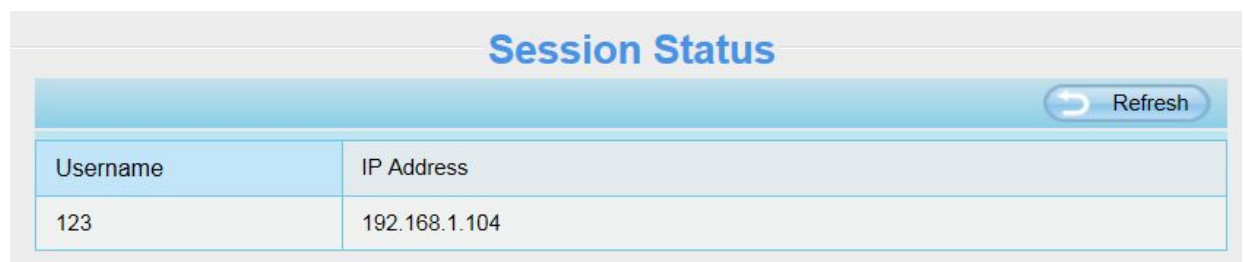

Session Status	
Username	IP Address
123	192.168.1.104

Figure 4.3

## 4.1.4 Log

The log record shows who and which IP address accessed or logout the camera and when.

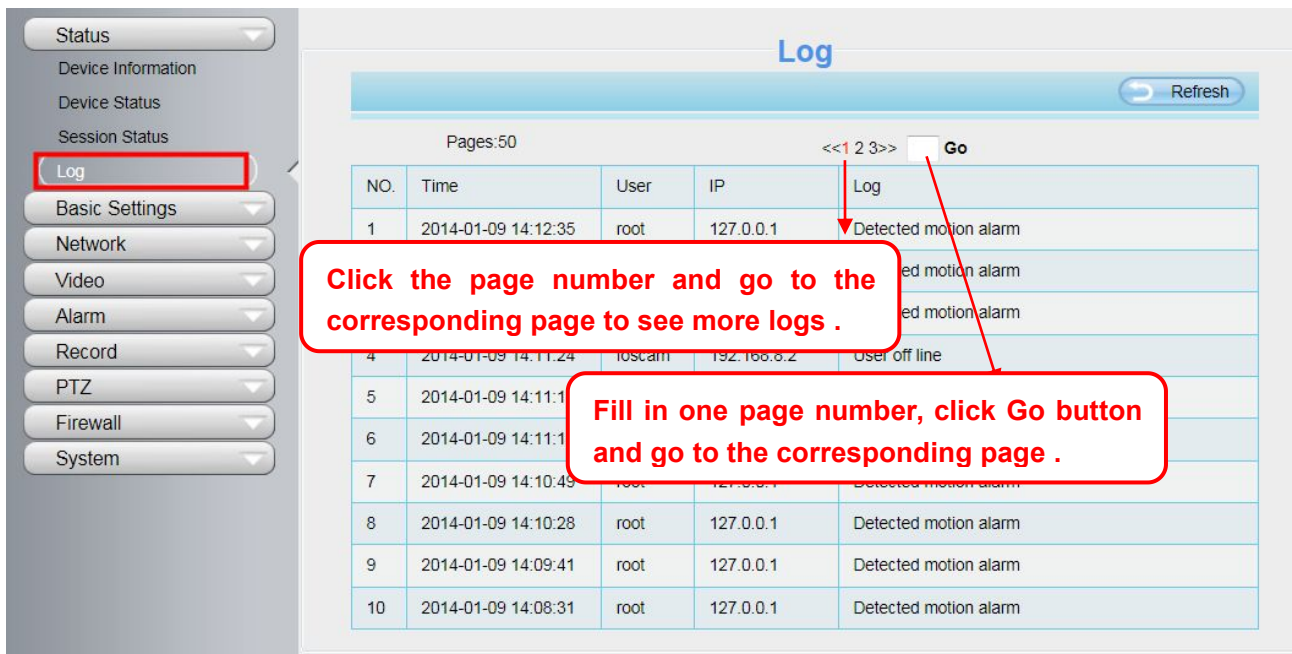

Figure 4.4

Reboot the camera and clear the log records.

## 4.2 Basic Settings

This section allows you to configure your Camera Name, Camera Time, Mail, User Accounts and Multi-Device.

### 4.2.1 Camera Name

Default alias is anonymous. You can define a name for your camera here such as apple. Click **Save** to save your changes. The alias name cannot contain special characters.

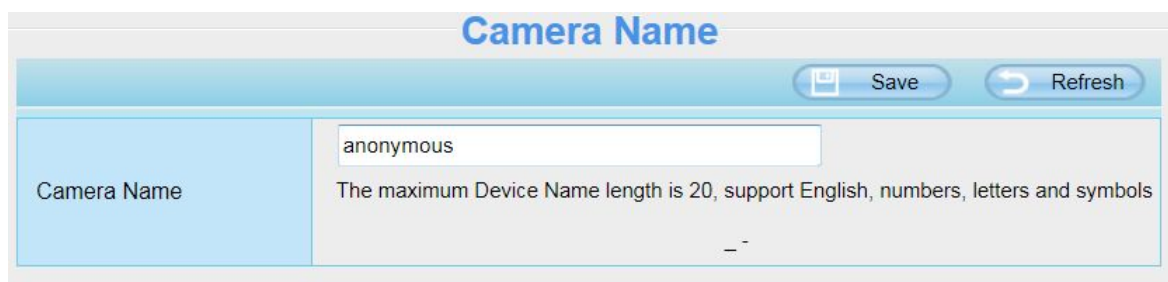

Figure 4.5

### 4.2.2 Camera Time

This section allows you to configure the settings of the internal system clocks for your camera.



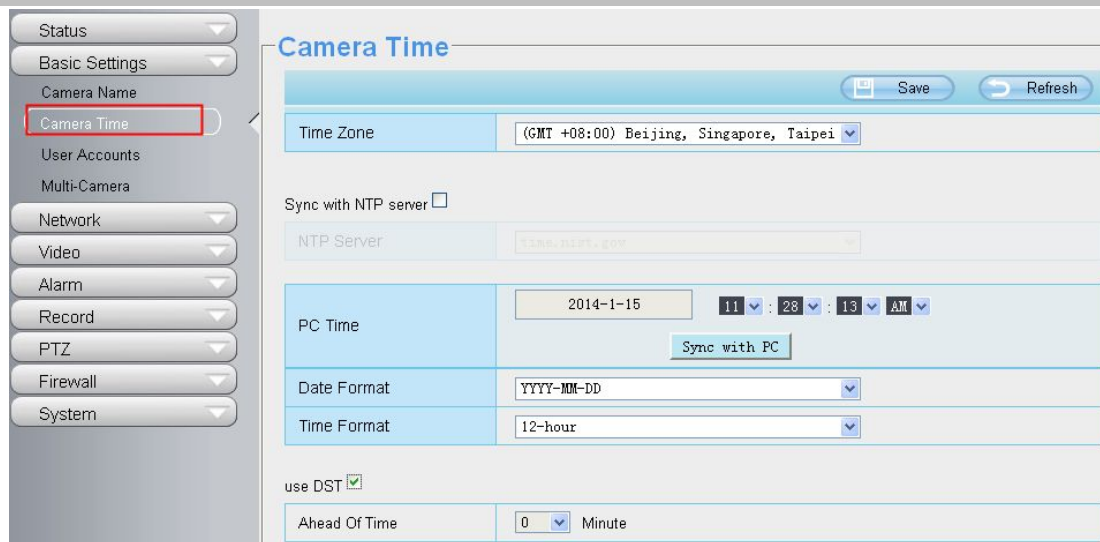

Figure 4.6

**Time Zone:** Select the time zone for your region from the drop-down menu.

**Sync with NTP server:** Network Time Protocol will synchronize your camera with an Internet time server. Choose the one that is closest to your camera.

**Sync with PC:** Select this option to synchronize the date and time of the Network Camera with your computer.

**Manually:** The administrator can enter the date and time manually. Please select the date and time format.

**use DST:** Select the **use DST**, then select the daylight saving time from the drop-down menu.

**Click Save** button to submit your settings.

**NOTE:** If the power supply of camera is disconnect, you need set the camera’s time again.

### 4.2.3 User Accounts

Here you can create users and set privilege, **visitor**, **operator** or **administrator**. The default administrator user accounts are admin with a blank password.

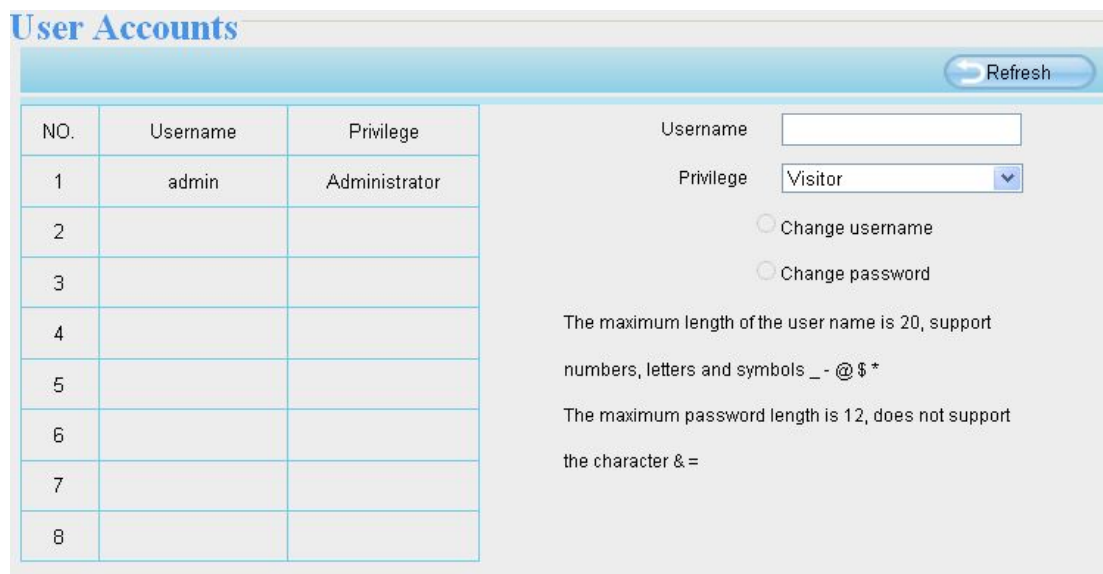

Figure 4.7

### How to change the password?

Firstly, select the account which you want to change the password, then select “Change password”, enter the old password and the new password, lastly click modify to take effect.

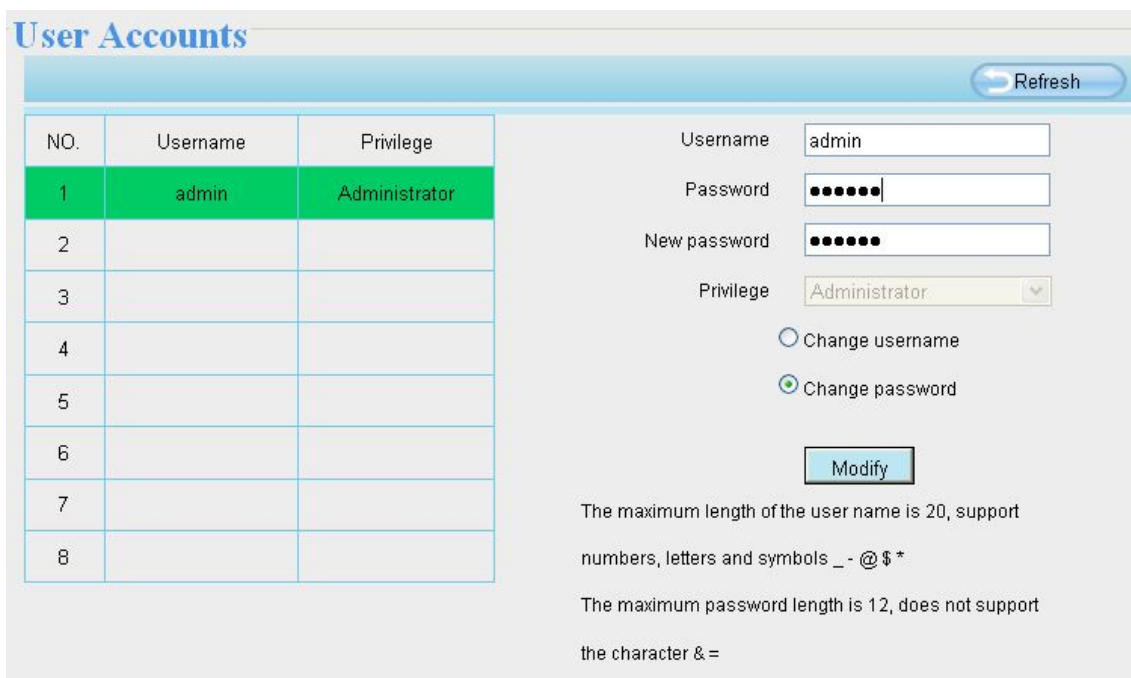

Figure 4.8

### How to add account ?

Select one blank column, then enter the new user name, password and privilege, last click Add to take effect. You can see the new added account on the Account list.

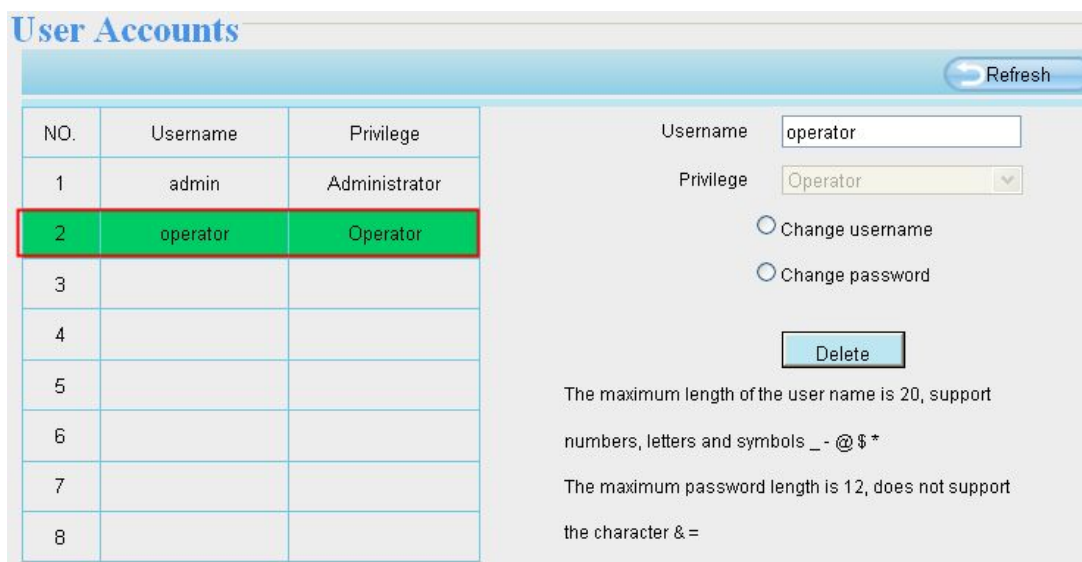

Figure 4.9

The screenshot displays the 'User Accounts' management page. On the left, a table lists users with columns for 'NO.', 'Username', and 'Privilege'. The second row, representing the 'operator' user, is highlighted in green. On the right, a form allows editing this user. The 'Username' field contains 'operator' and the 'Privilege' dropdown is set to 'Operator'. Below these fields are radio buttons for 'Change username' and 'Change password', and a 'Delete' button. A 'Refresh' button is located at the top right of the interface. Below the form, there are two lines of text providing constraints: 'The maximum length of the user name is 20, support numbers, letters and symbols \_ - @\$ \*' and 'The maximum password length is 12, does not support the character & ='.

NO.	Username	Privilege
1	admin	Administrator
2	operator	Operator
3		
4		
5		
6		
7		
8		

Figure 4.10

**Delete:** Select the account which you want to delete, then click Delete button to take effect.

**NOTE:**

The default administrator account cannot be deleted, but you can add other administrator users.

## 4.2.4 Multi-Camera

If you want to view multi-surveillance screens on one window, you need to login one camera, and set it as the main device, and do Multi-Device Settings, add other cameras to the first one camera. Before you do multi-cams settings, you need to assign different port such as 81, 82, 83, 84, 85, 86, 87, 88 to the cameras if there is 8 cams installed.

The firmware within the camera can support a maximum of 9 devices monitoring all at the same time. This page you can both add MJPEG and H.264 series cameras to the first camera and view multi-surveillance screen on one window.

### Add cameras in LAN

In Multi-Device Settings page, you can see all devices searched in LAN. The 1st Device is the default one. You can add more cameras in the list in LAN for monitoring. The camera's software supports up to 9 IP Cameras online simultaneously. Click The **2nd Device** and click the item in the Device List in LAN, the Alias, Host and Http Port will be filled in the boxes below automatically. Enter the correct username and password then click **Add**. Add more cameras in the same way.

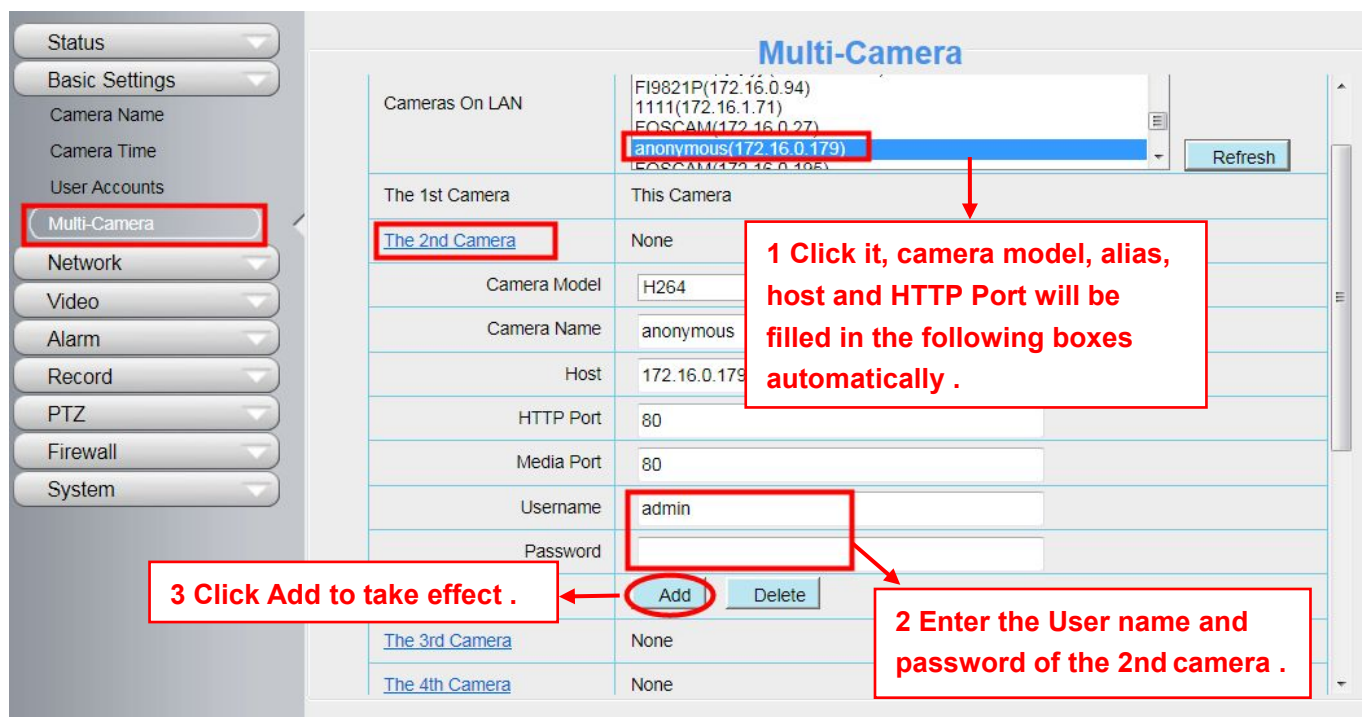

Figure 4.11

**Camera Model:** Our Company produces two series cameras: MJPEG and H.264. Here will show you which series the camera belongs to.

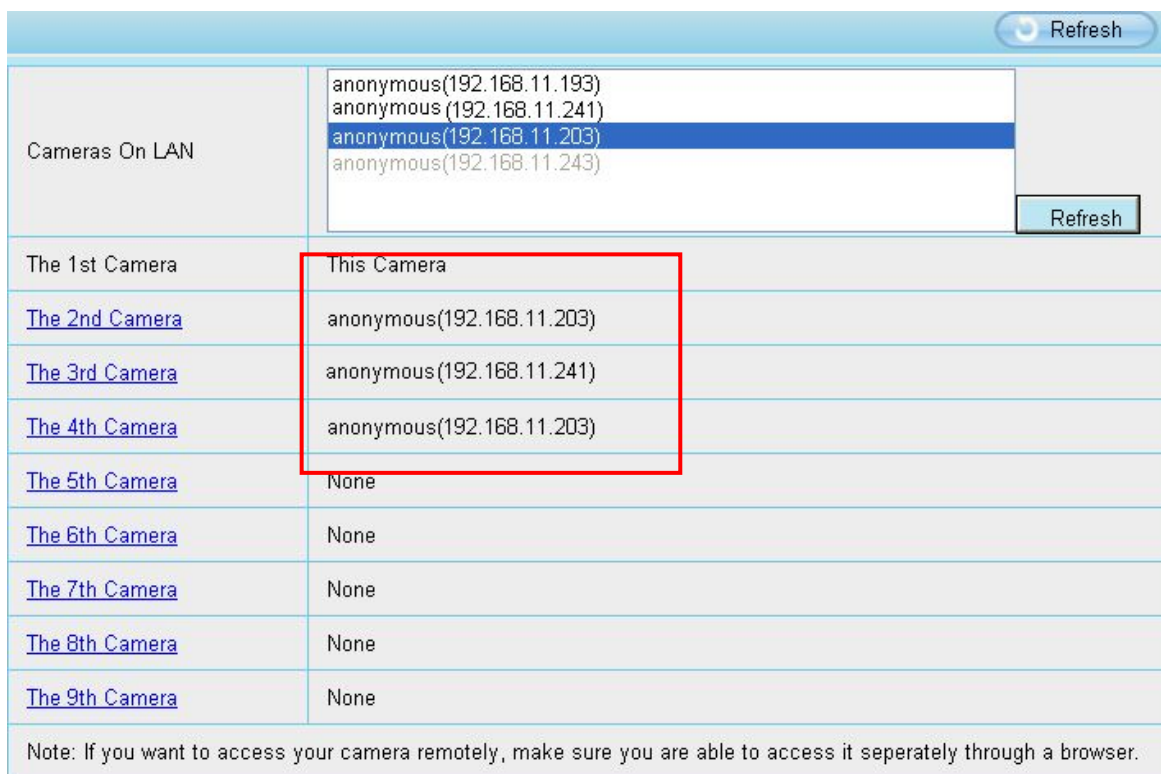

Figure 4.12

Back to Surveillance Windows, and click Four Windows option, you will see four cameras you added.

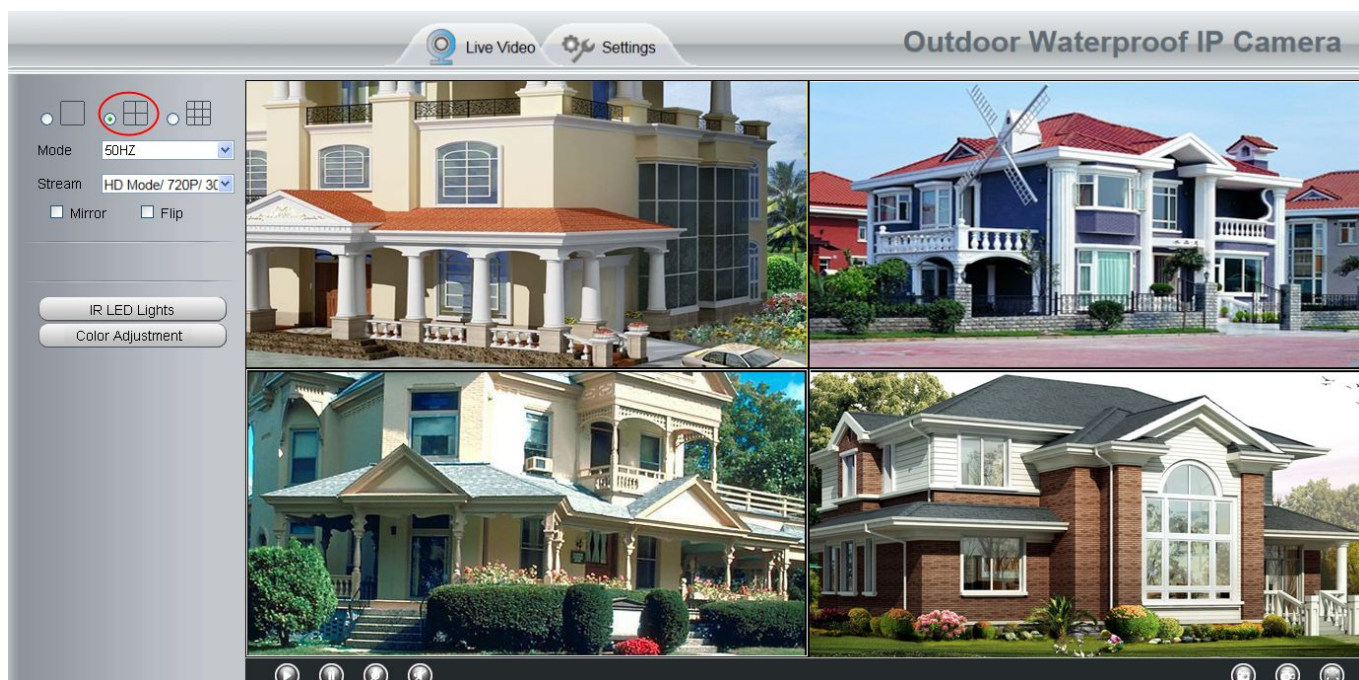

Figure 4.13

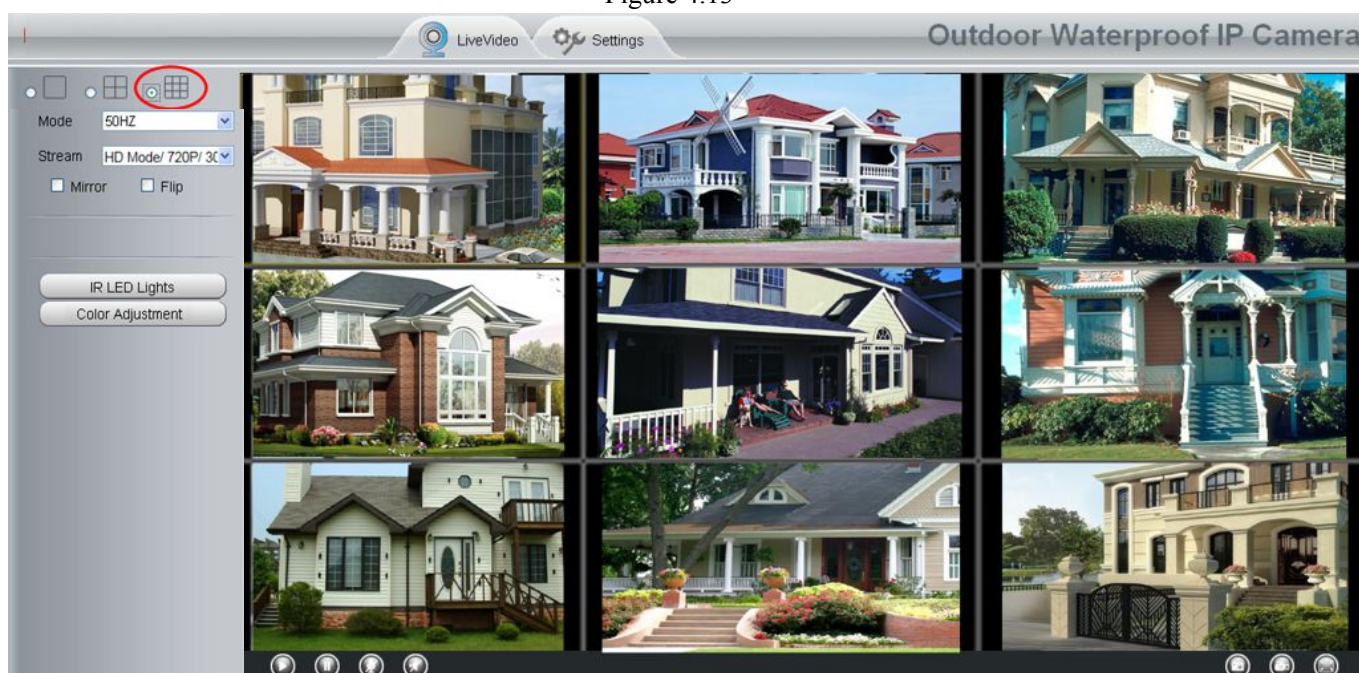

Figure 4.14

### Add cameras in WAN

If you want to view all cameras via the internet(remote computer), you will need to add them using DDNS domain name. Firstly, make sure all of the cameras you added can be accessed through the internet. Login to the first camera using a DDNS domain name and port.

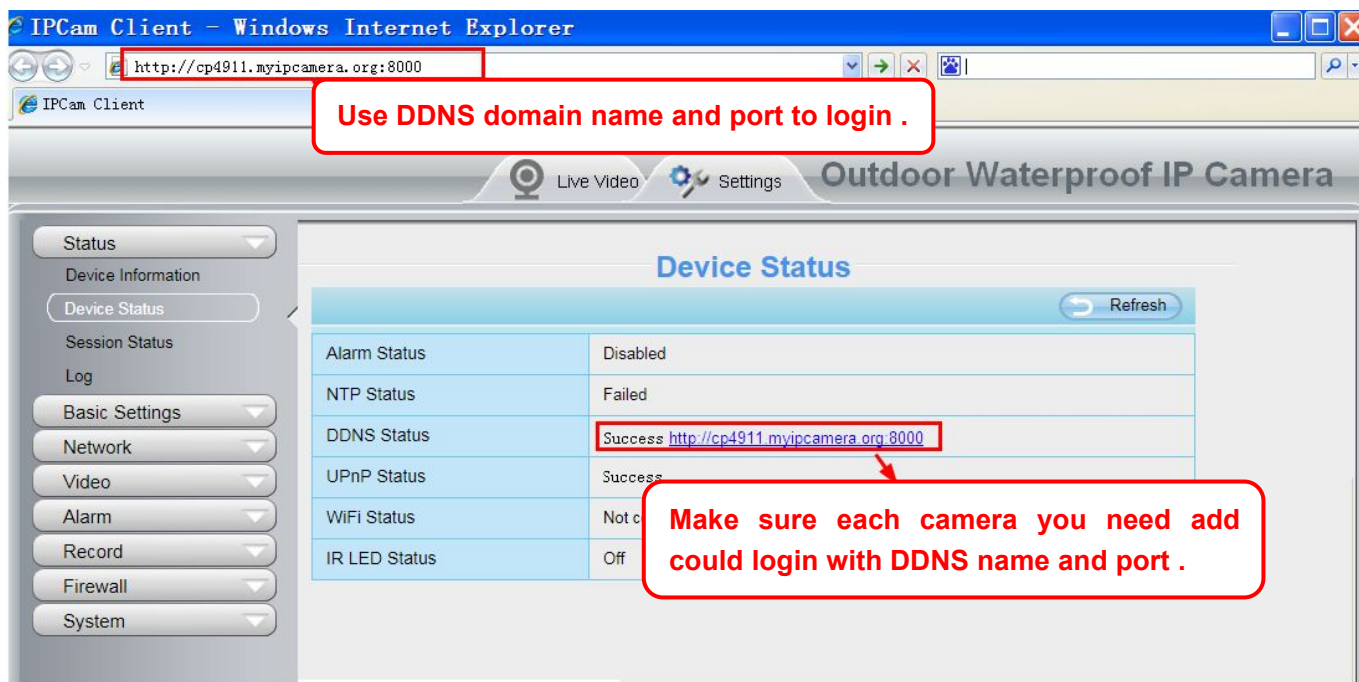

Figure 4.15

Click Multi-Device Settings. Choose The 2nd Device. Fill in the 2nd camera's name, DDNS domain name, port number. Enter user name and password and then choose Add.

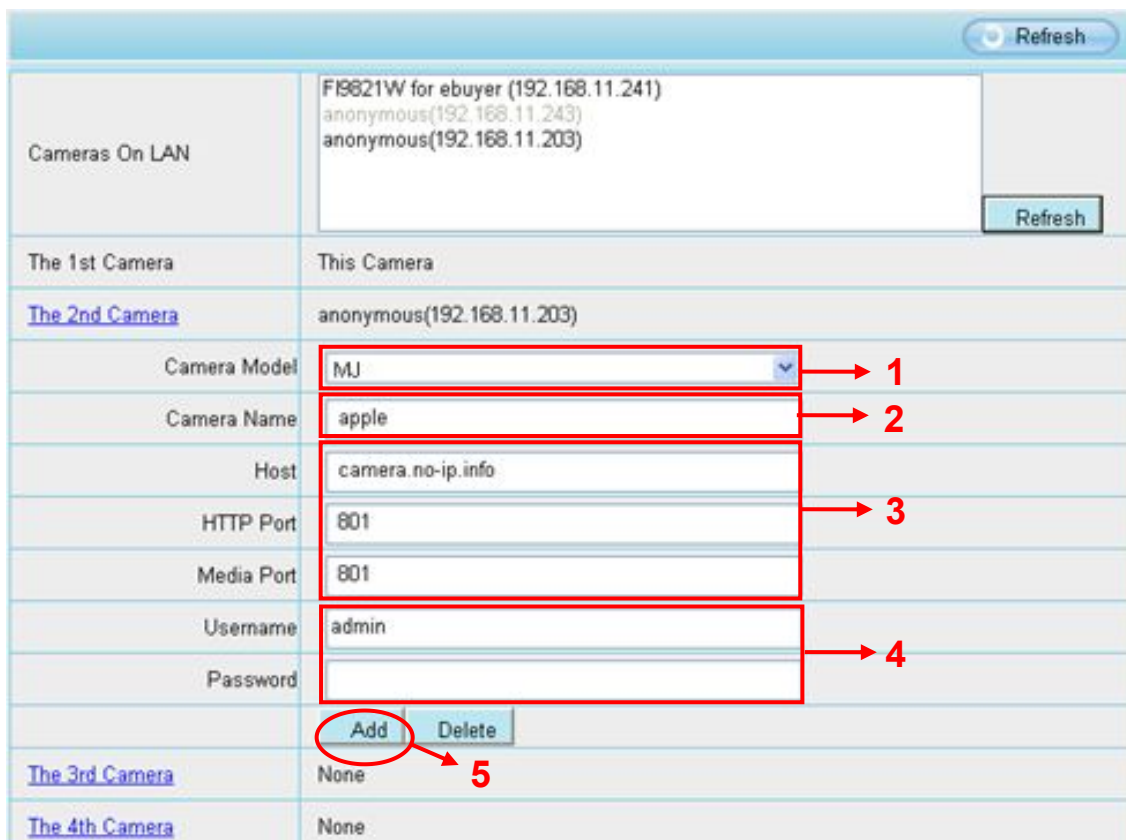

Figure 4.16

- 1----- The camera model: MJ or H264.
- 2----- The 2nd camera's name

- 3----- Fill in the 2nd camera's DDNS host not LAN IP
- 4 ---- Enter the 2nd camera's user name and password
- 5---- Click Add button and to take effect

**NOTE:** Here the Host must be entered as the second camera's DDNS domain name, not its LAN IP.



Figure 4.17

Return to video window. You will see all of the cameras accessible through the internet.

When you are away from home, you can use the first camera's DDNS domain name and port to view all the cameras via internet.

## 4.3 Network

This section will allow you to configure your camera's IP, PPOE, DDNS, UPnP, Port, Mail Settings and FTP Settings.

### 4.3.1 IP Configuration

If you want to set a static IP for the camera, please go to **IP Configuration** page. Keep the camera in the same subnet of your router or computer.

Save Refresh	
Obtain IP From DHCP <input type="checkbox"/>	
IP Address	192.168.0.109
Subnet Mask	255.255.255.0
Gateway	192.168.0.1
Primary DNS Server	192.168.0.1
Secondary DNS Server	202.96.134.133

Note: Once you save your settings, the camera will restart.

Figure 4.18

Changing settings here is the same as using the Equipment Search Tool.

It is recommended that you use the subnet mask, gateway and DNS server from your locally attached PC. If you don't know the subnet mask, gateway and DNS server, you can check your computer's local area connection as follows:

**Control Panel--Network Connections--Local Area Connections --Choose Support--Details.**

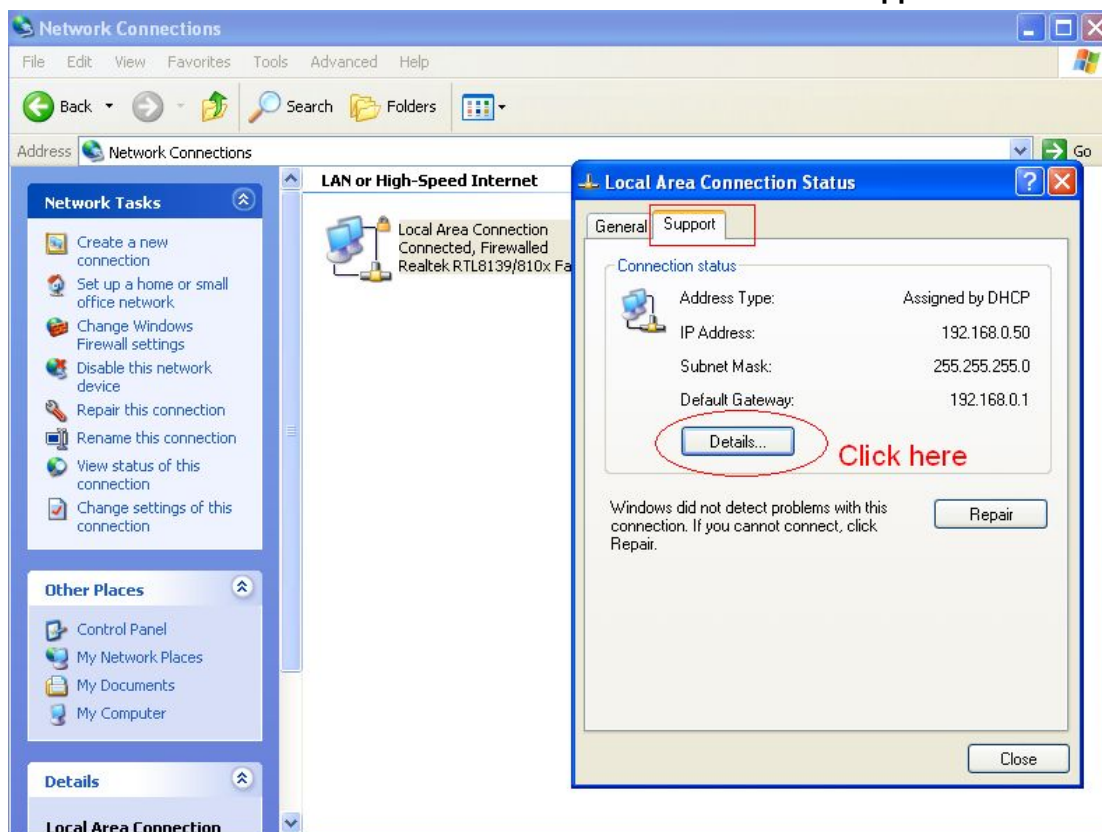

Figure 4.19



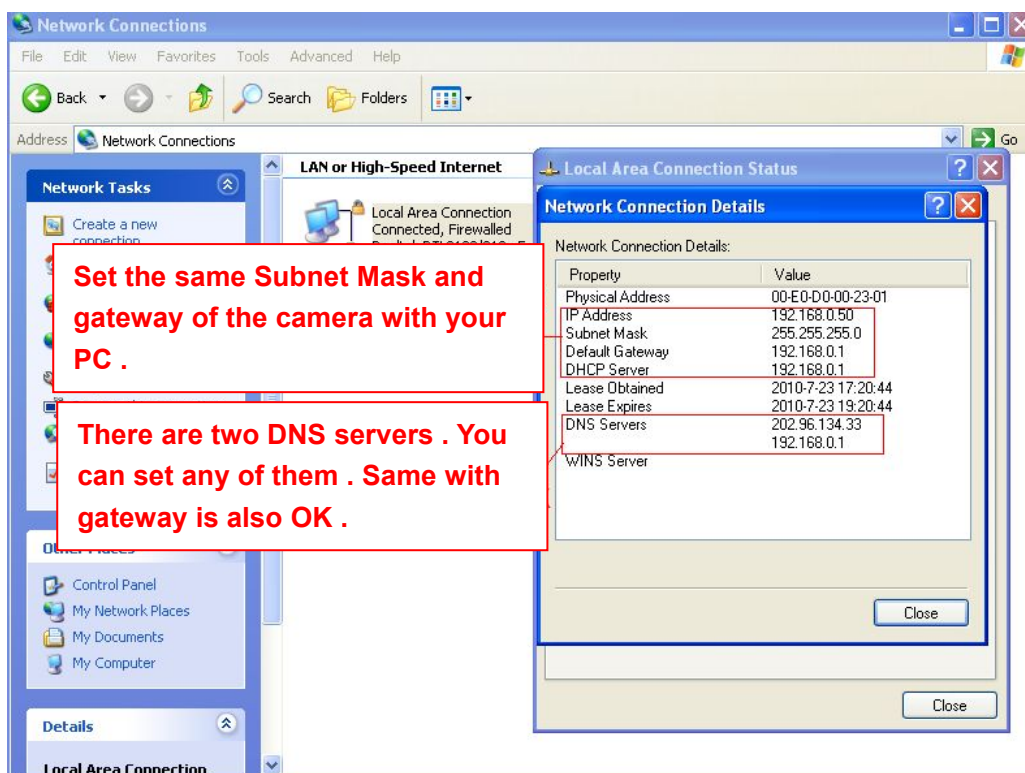

Figure 4.20

If you don't know the DNS server, you can use the same settings as the Default Gateway.

### 4.3.2 DDNS

Camera has embedded a unique DDNS domain name when producing, and you can directly use the domain name, you can also use the third party domain name.

#### IPCAM domain name

Here take **cp4911.myipcamera.org** for example. Go to option of DDNS on the **Settings->Network** panel, you can see the domain name.

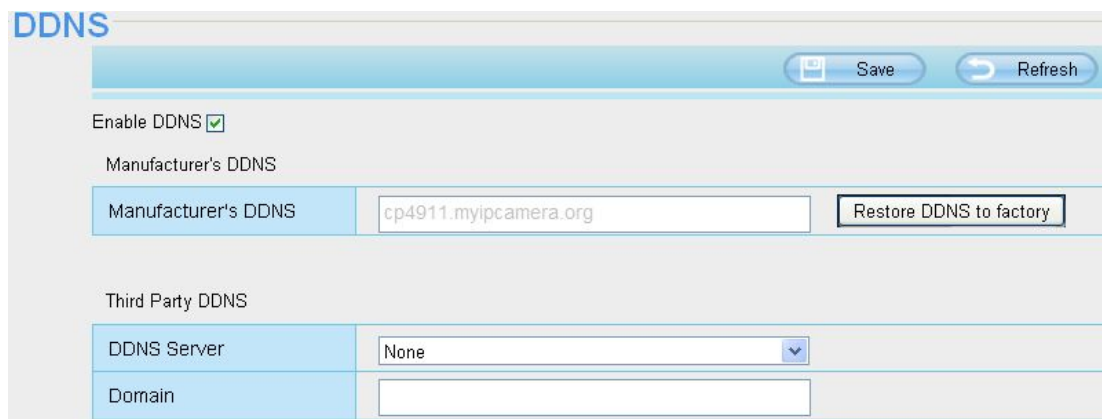

Figure 4.21

Now you can use **http:// Domain name + HTTP Port** to access the camera via internet.

Take hostname **cp4911.myipcamera.org** and HTTP Port no. 8000 for example, the accessing link of the camera via internet would be **http://cp4911.myipcamera.org:8000**

**Restore DDNS to factory:** If you have configured Third Party DDNS successfully, but you want to use Manufacturer's DDNS again , here click this button and start Manufacturer's DDNS Service.

### Third Party Domain Name Settings

User can also use third part DDNS, such as [www.no-ip.com](http://www.no-ip.com) , [www.3322.com](http://www.3322.com)

Here take **www.no-ip.com** for example :

① **Step 1** Go to the website **[www.no-ip.com](http://www.no-ip.com)** to create a free hostname

Firstly: Login on **[www.no-ip.com](http://www.no-ip.com)** and click No-IP Free to register.



Figure 4.22

Please register an account step by step according to instructions on **[www.no-ip.com](http://www.no-ip.com)**

After registration, please login your email which used to register. You will receive an email from website, please click the link to activate your ACCOUNT as indicated in email.

**Secondly:** Login the link with the registered username and password to create your domain name.

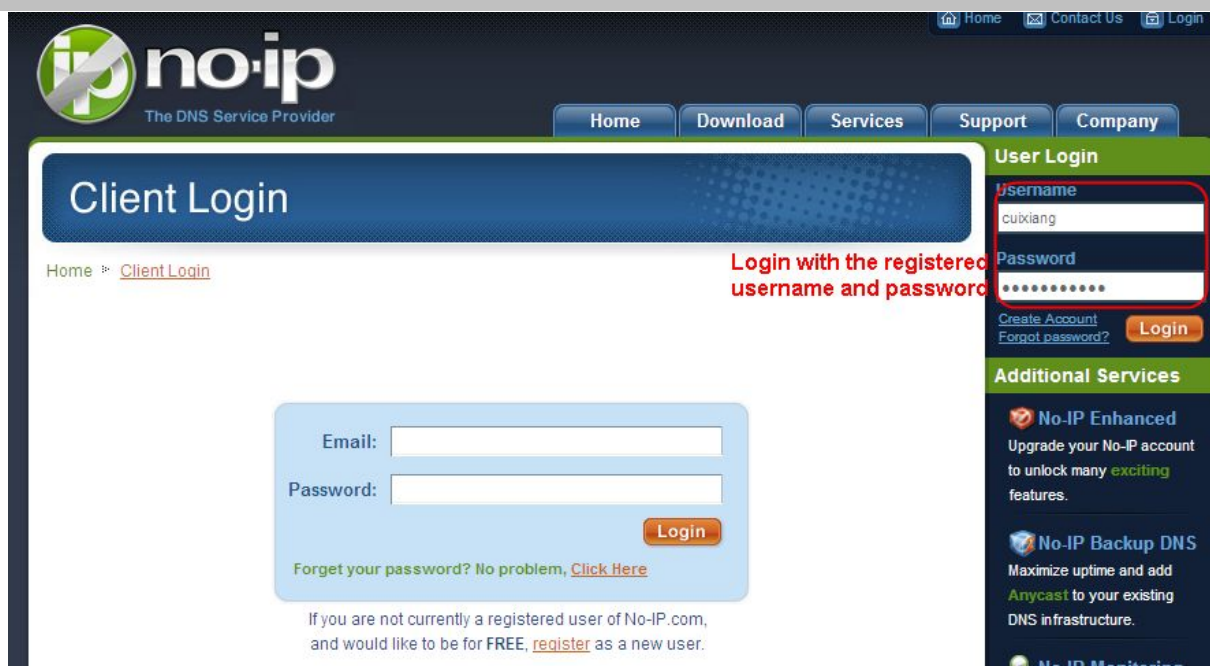

Figure 4.23

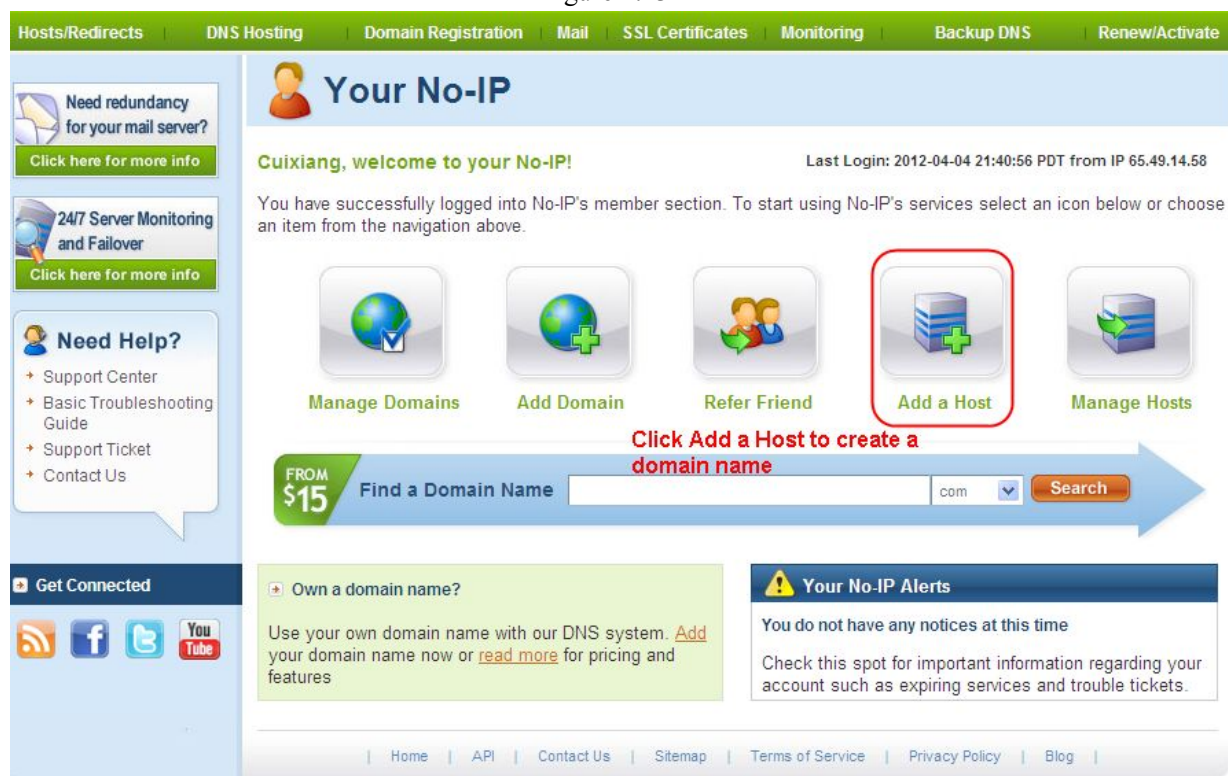

Figure 4.24

Please create the domain name step by step according to instructions on [www.no-ip.com](http://www.no-ip.com)

### Step 2 DO DDNS Service Settings within the Camera

Please set DDNS Settings within the camera by hostname, a user name and password you've got from [www.no-ip.com](http://www.no-ip.com)

Take hostname `ycxgwp.no-ip.info`, user name **camera**, password **camera2012** for example.

**Firstly**, goes to option of DDNS Settings on the administrator panel.

**Secondly**, select No-Ip as a server.

**Thirdly**, fill camera as DDNS user, fill password camera2012 as DDNS password, fill ycxgwp.no-ip.info as DDNS domain and server URL, Then click save to make effect. The camera will restart and to take the DDNS settings effective.

**Fourthly**, after the restart, login the camera, and go to option of Device Status on the administrator panel, and check if the DDNS status is successful.

If failed, please double check if you have input the correct hostname, user name, and password, and try to redo the settings.

**NOTE :**

If you have set Third Party DDNS successfully ,the camera Domain Name will be invalid. The Third Party DDNS and the camera Domain Name cannot work at the same time, the last time you configured will take effect.

**② Do port forwarding within the router**

**Example: The camera’s LAN IP address is http://192.168.8.100:2000**

**Firstly**, login the router, goes to the menu of Port Forwarding or Port Trigger (or named Virtue Server on some brands of router). Take Linksys brand router as an example, Login the router, and goes to Applications & Gaming->Single Port Forwarding.

**Secondly**, Create a new column by LAN IP address & HTTP Port No. of the camera within the router showed as below.

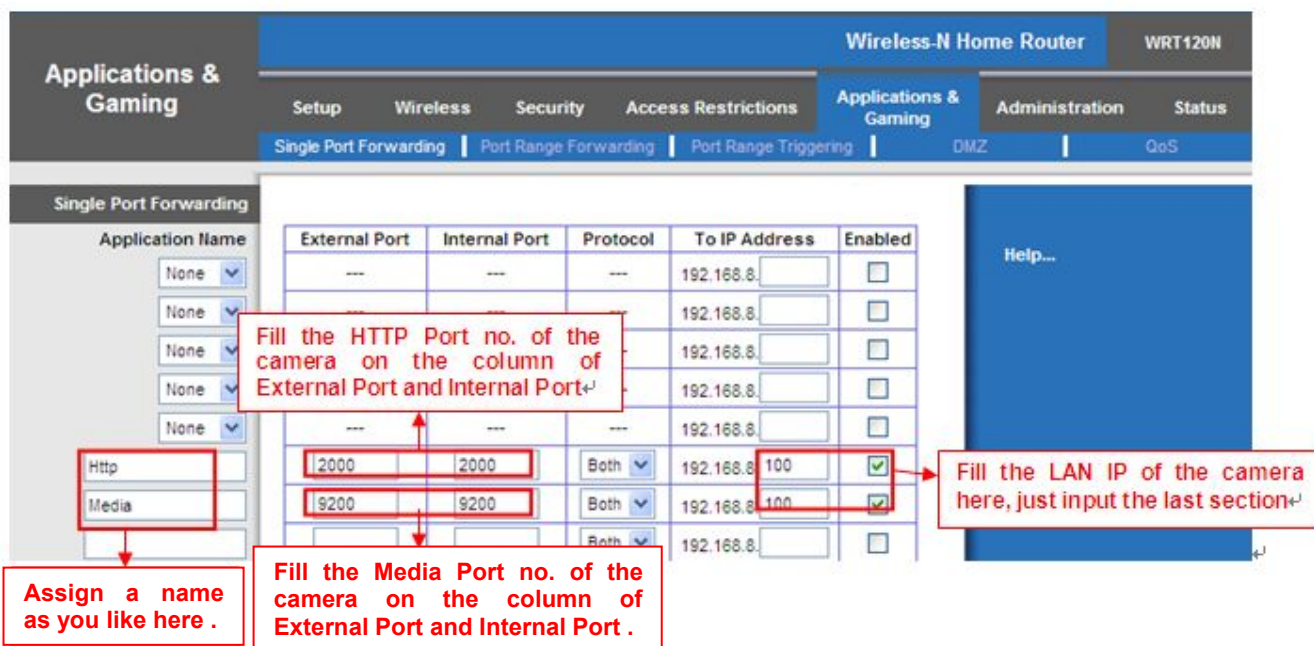

Figure 4.25

**③ Use domain name to access the camera via internet**

After the port forwarding is finished, you can use the **domain name+ http no.** to access the camera via internet. Take hostname ycxgwp.no-ip.info and http no. 2000for example, the accessing link of the camera via internet would be `http:// ycxgwp.no-ip.info:2000`

### 4.3.3 UPnP

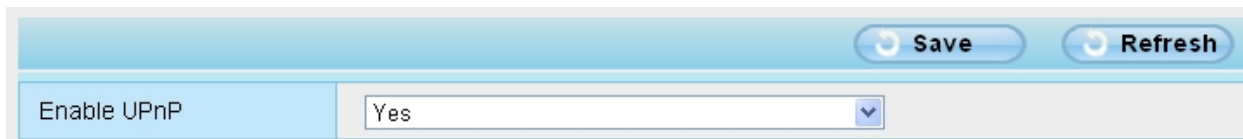

Figure 4.26

The default UPnP status is closed. You can enable UPnP, then the camera’s software will be configured for port forwarding. Back to the “Device Status” panel, you can see the UPnP status:

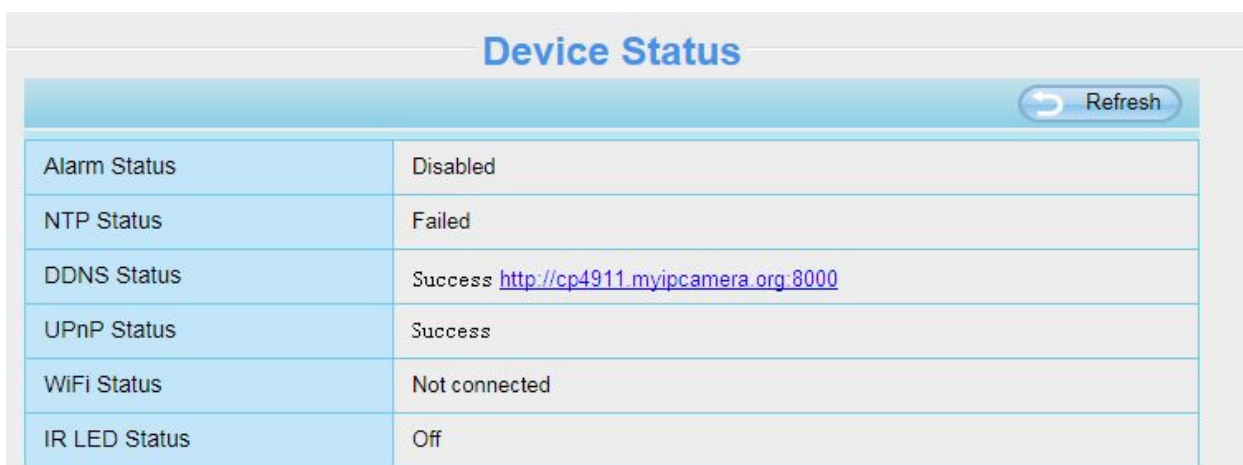

Figure 4.27

The camera’s software will be configured for port forwarding. There may be issues with your routers security settings, and sometimes may error. We recommend you configure port forwarding manually on your router .

### 4.3.4 Port

This camera supports HTTP Port / HTTPS Port/ ONVIF Port. HTTP Port is used to access the camera remotely.

**HTTP port** : By default, the HTTP is set to 88. Also, they can be assigned with another port number between 1 and 65535. But make sure they can not be conflict with other existing ports like 25, 21.



Figure 4.28

**Another way to change the HTTP port no.**

**Step 1:** Open the Equipment Search Tool, select the camera you would like to change the port of, right click on the IP address, and click on "Network Configuration", this brings up the network configuration box .

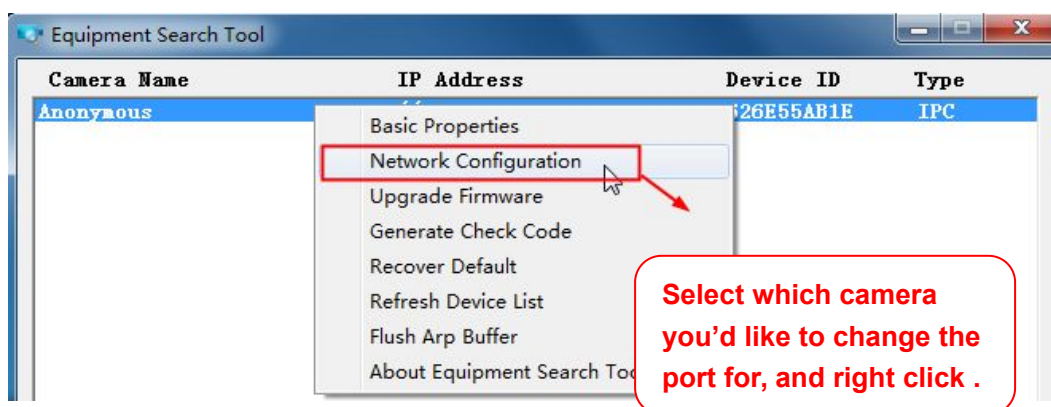

Figure 4.29

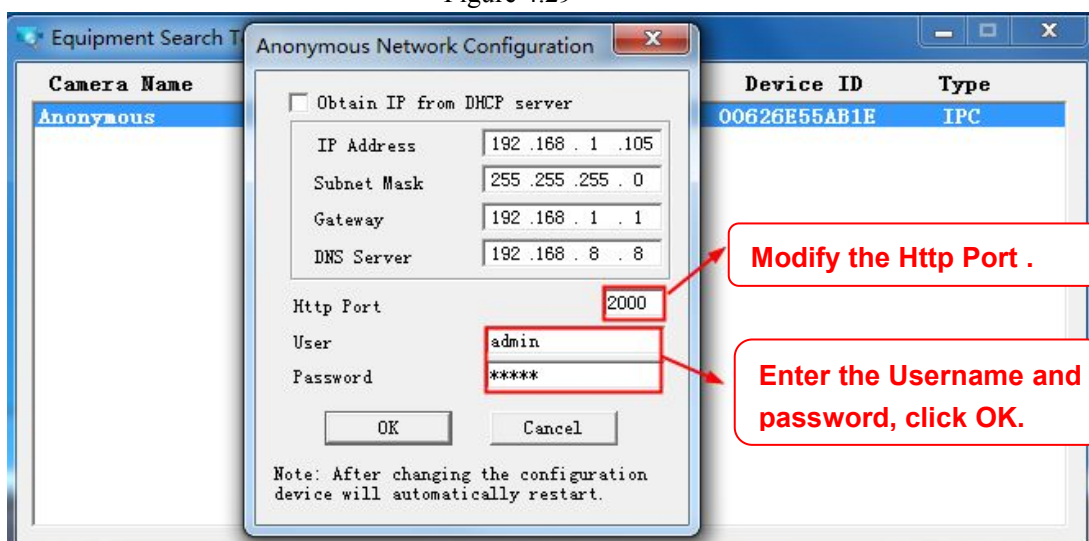

Figure 4.30

**Step 2:** Enter the username and password of the Administrator (default username is admin with a blank password), and click "OK" to apply changes.

**Step 3:** Wait around 10 seconds, you'll see that the camera's LAN IP address has changed. In our example it was changed to 2000, so we see http://192.168.1.105:2000 in Equipment Search Tool. Also, the LAN IP address is now fixed at a static IP address of http://192.168.1.105:2000. This IP address will not change even if the camera is powered off and back on, the camera will remain on this LAN IP address. This is very important that a static LAN IP address is set, or you may have problems later with remote access and seeing the camera remotely if the camera loses power and reconnects on a different LAN IP address. Make sure you set a static LAN IP address!



Figure 4.31

**NOTE:** If the camera cannot be accessed, please make sure the port forwarding is succeed.

**HTTPS port:** The default port is 443. You can use the url to access the camera: https:// IP + HTTPS port.

**ONVIF port:** By default, the ONVIF port is set to 888. Also, they can be assigned with another port number between 1 and 65535(except 0 and 65534). But make sure they can not be conflict with other existing ports.

**RTSP port:**The default port is 554,only some IP Cameras have RTSP port.

### 4.3.5 Mail Settings

If you want the camera to send emails when motion has been detected, here Mail will need to be configured.

Figure 4.32

**1----- SMTP Server/ Port /Transport Layer Security** Enter SMTP server for sender. SMTP port is usually set as 25. Some SMTP servers have their own port, such as 587 or 465, and Transport Layer Security usually is None. If you use Gmail, Transport Layer Security must be set to TLS or STARTTLS and SMTP Port must be set to 465 or 25 or 587, which port you choose should be decided by which Transport Layer Security you select.

**2-----SMTP Username/ password:** ID account and password of the sender email address

**3----- Sender E-mail** Mailbox for sender must support SMTP

**4----- Receiver** Mailbox for receiver need not support SMTP, you can set 4 receivers

**5----- Save** Click Save to take effect

**6----- Test** Click Test to see if Mail has been successfully configured.

Click Test to see if Mail has been successfully configured.

SMTP Configuration	
Enable	<input checked="" type="checkbox"/>
SMTP Server	smtp.gmail.com
SMTP Port	25
Transport Layer Security	STARTTLS <small>G-Mail only supports TLS at Port 465 and STARTTLS at Port 587 or 25.</small>
Need Authentication	No
SMTP Username	yaoyao@gmail.com
SMTP Password	..... <input type="button" value="Test"/> Success
Sender E-mail	yaoyao@gmail.com
First Receiver	yaoyao@163.com
Second Receiver	
Third Receiver	
Fourth Receiver	

Figure 4.33

If the test success, you can see the Success behind the Test, at the same time the receivers will receive a test mail.

If the test fails with one of the following errors after clicking Test, verify that the information you entered is correct and again select Test .

- 1) Cannot connect to the server
- 2) Network Error. Please try later
- 3) Server Error
- 4) Incorrect user or password
- 5) The sender is denied by the server. Maybe the server need to authenticate the user, please check it and try again
- 6) The receiver is denied by the server. Maybe because of the anti-spam privacy of the server
- 7) The message is denied by the server. Maybe because of the anti-spam privacy of the server
- 8) The server does not support the authentication mode used by the device

### 4.3.6 FTP Settings

If you want to upload record images to your FTP server, you can set **FTP Settings**.



<input type="button" value="Save"/> <input type="button" value="Refresh"/>	
FTP Server	<input type="text" value="ftp://192.168.8.150"/> Example:ftp://192.168.1.103/dir The maximum length of the address is 127, does not support the character & =
Port	<input type="text" value="21"/>
FTP Mode	<input type="text" value="PORT"/> <input type="button" value="v"/>
Username	<input type="text" value="yaocuixiang"/> The maximum length of the user name is 63, support numbers, letters and symbols _ @ \$ * - . , # !
Password	<input type="password" value="●●●●●●●●"/> The maximum password length is 63, does not support the character & =
<input type="button" value="Test"/>	<input type="text" value="Success"/>

Figure 4.34

<input type="button" value="Save"/> <input type="button" value="Refresh"/>	
FTP Server	<input type="text" value="ftp://ftp.mgenseal.com"/> Example:ftp://192.168.1.103/dir The maximum length of the address is 127, does not support the character & =
Port	<input type="text" value="21"/>
FTP Mode	<input type="text" value="PORT"/> <input type="button" value="v"/>
Username	<input type="text" value="deotestge"/> The maximum length of the user name is 63, support numbers, letters and symbols _ @ \$ * - . , # !
Password	<input type="password" value="●●●●●●●●"/> The maximum password length is 63, does not support the character & =
<input type="button" value="Test"/>	<input type="text" value="Success"/>

Figure 4.35

**FTP server:** If your FTP server is located on the LAN, you can set as Figure 4.38.

If you have an FTP server which you can access on the internet, you can set as Figure 4.39.

**Port:** Default is port 21. If changed, external FTP client program must change the server connection port accordingly.

**FTP Mode:** Here supports two modes: PORT and PASV.

**Username/password:** The FTP account and password.

Click Save to take effect.

Click Test to see if FTP has been successfully configured.

### 4.3.7 P2P

Access the camera by smart phone (Android or iOS operating system), please refer to the Quick Installation Guide.

First of all, you need to open the P2P function of the camera at “Settings-->Network-->P2P.”

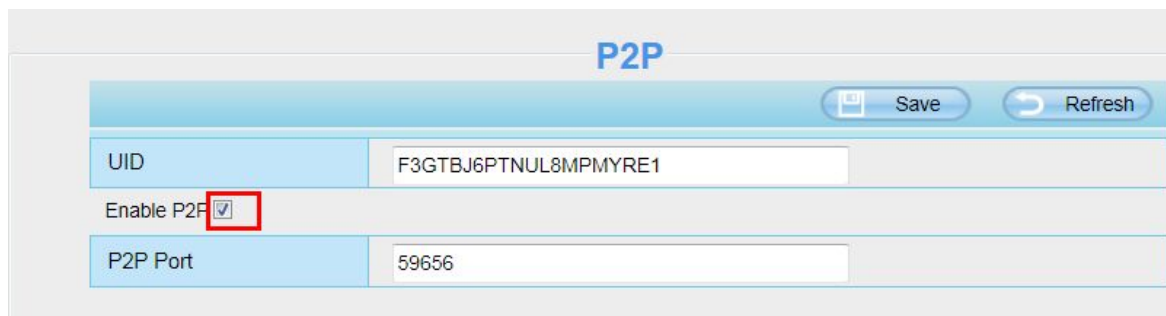

Figure 4.36

## 4.4 Video

This section allows you to configure Video stream settings, On screen display and Snapshot settings.

### 4.4.1 Video Settings

There are two ways to set the stream video settings. They are main stream video settings and sub stream video settings.

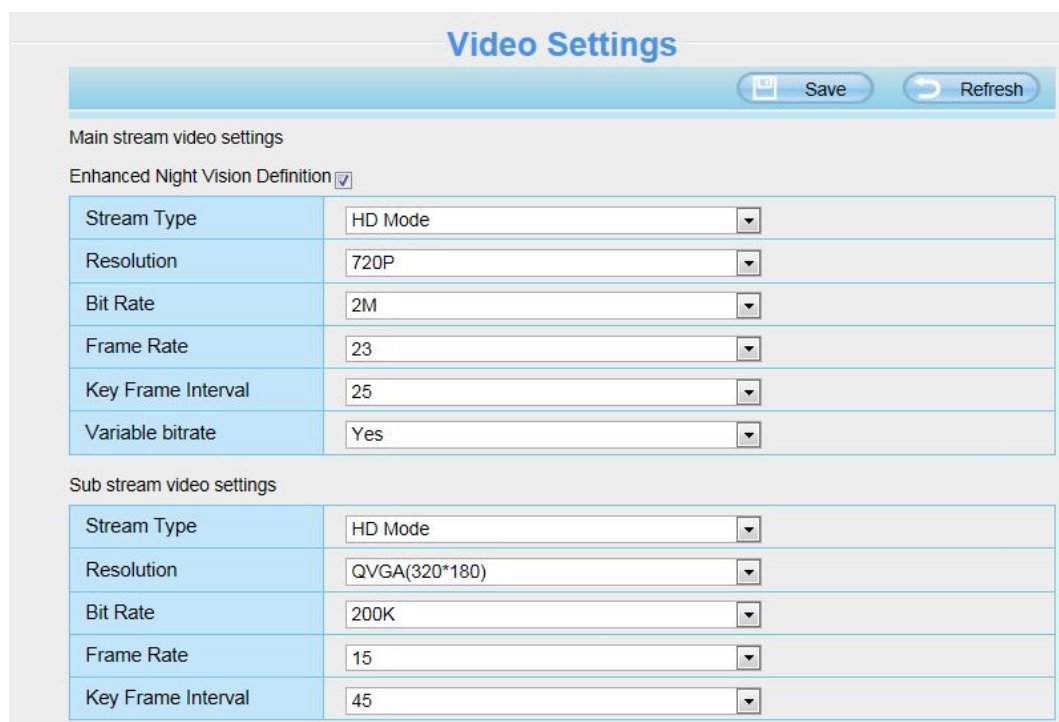

Figure 4.37

**Enhanced Night video Definition:** The camera will automatically drop the frame to extend the recording time in the night.

**Stream Type:** There are four types to identify different streams you have set. If select the HD Mode, the clearer video will become, and it will take up more bandwidth; If select the Smooth Mode, the bandwidth is very narrow, and bit rate is large, that will lead to video can not play well. The Equilibrium Model is a value between HD Mode and Smooth Mode.

**Resolution:** The camera supports multiple types, For example: 1080P, 960P, 720P, VGA. The higher the resolution is, the clearer video will become. But the code flux will become larger too, and it will take up more bandwidth. (Different models support different specific types. )

**Bit Rate:** Generally speaking, the larger the bit rate is, the clearer video will become. But the bit rate configuration should combine well with the network bandwidth. When the bandwidth is very narrow, and bit rate is large, that will lead to video can not play well.

**Frame Rate:** Note that a larger frame size takes up more bandwidth. You should lower frame rate when the bandwidth is limited. Normally, when the frame rate above 15, you can achieve fluently video. The maximum frame rate for each model is different, please see the “**Specifications**” .

**Key Frame Interval:** The time between last key frame and next key frame. The shorter the duration, the more likely you will get a better video quality, but at the cost of higher network bandwidth consumption.

**Variable bitrate:** Select the Bit rate type to constant or variable. If select Yes, the camera will change the video bit rate according to the situation, but will not more than the maximum parameter "Bit Rate"; If select No, the Bit Rate is unchanged.

**Rate Control Mode:** There are three rate control modes.

CBR: Constant Bit Rate, it means that the Bit Rate is constant.

VBR: Variable Bit Rate, the camera will change the video bit rate according to the situation, but will not more than the maximum parameter "Bit Rate".

LBR: Low Bit Rate. If you can select the LBR, then you can slide the scroll bar to choose percentage of the bit rate. By reducing the bit rate, so that the camera can obtain a better image at low bandwidth.

## 4.4.2 On Screen Display

This page is used to add timestamp and device name on the video.



On Screen Display Configuration	
Display Timestamp	Yes
Display Camera Name	Yes

Figure 4.38

**Display Timestamp:** There are two options: Yes or NO. Select Yes and you can see the system date on the video.

**Display Camera Name:** There are two options: Yes or NO. Select Yes and you can see the device name on the video.

### 4.4.3 Privacy Zone

Some models do not support this Function.

This page is used to add privacy zone on the video.

Privacy Zone	
Allow Privacy Zone	Yes
Set Privacy Zone	

Figure 4.39

#### Allow On Screen Display Mask

There are two options: Yes or NO. Select yes and draw a mask area on the video, the mask area will be black on the video.

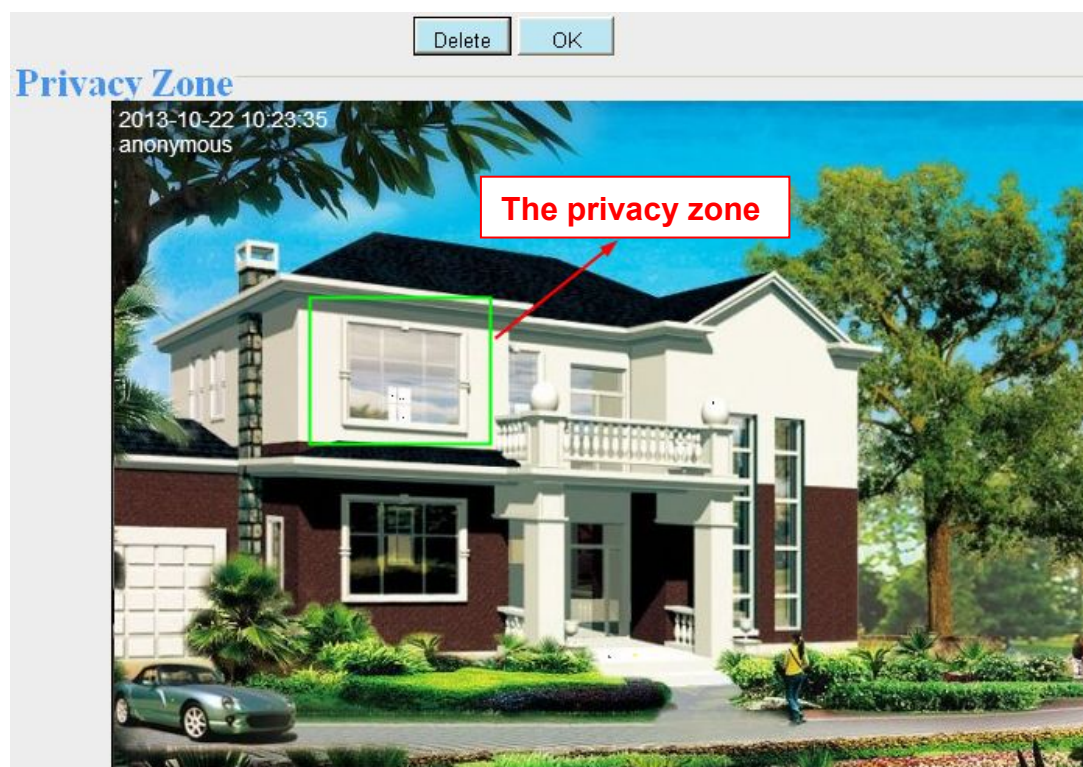

Figure 4.40

Click **OK** button and return to the **Privacy Zone** page, click Save to take effect.

Back to the surveillance window, you can see the privacy area as the following picture:



Figure 4.41

### 4.4.4 Snapshot Settings

On this page you can set the snapshot pictures' image quality and the storage path.

### Snapshot Settings

Manual snap Quality	Medium
Pictures Save To	FTP

Enable timing to capture:

Capture interval	2 (1-65535s)
------------------	--------------

All	00	01	02	03	04	05	06	07	08	09	10	11	12	13	14	15	16	17	18	19	20	21	22	23
MON																								
TUE																								
WED																								
THU																								
FRI																								
SAT																								
SUN																								

Figure 4.42

**Manual snap Quality:** Low, Middle and High. The higher the quality, the picture will be clearer.

**Pictures Save To:** FTP. If you have done FTP and Alarm settings, when alarming, the camera will snap pictures to the FTP automatically.

### Enable timing to capture

To enable capture interval, follow the steps below:

**1 Select Enable timing to capture**

**2 Capture interval:**The interval time between two captures.

**3 Select the capture time**

- Capture anytime

Click the black button up the MON, you will see all time range turn red. When something moving in the detection area at anytime, the camera will capture.

- Specify an capture schedule

Click the week day words, the corresponding column will be selected. For example, click TUE, the all column of TUE turns to red, that means during Tuesday whole day, the camera will capture.

- Press the left mouse and drag it on the time boxes, you can select the serial area,

**4 Click Save** button to take effect.

## 4.4.5 IR LED Schedule

On this page you can set the schedule time for switching IR LED lights. When parameter Mode is set to the **Schedule** on the Live **Video** window, At these schedule time, the IR LED lights will be turned off.

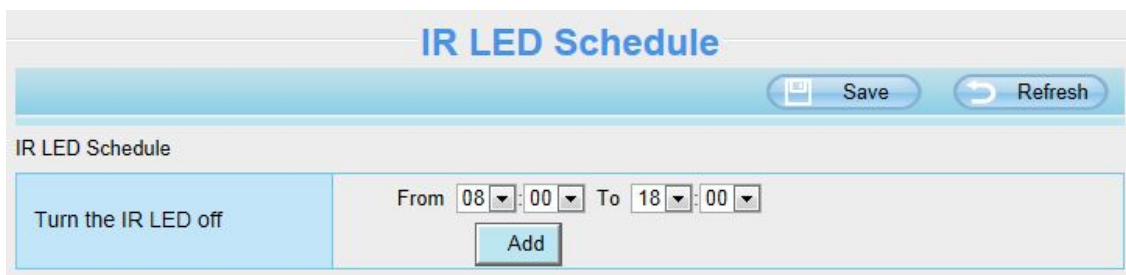
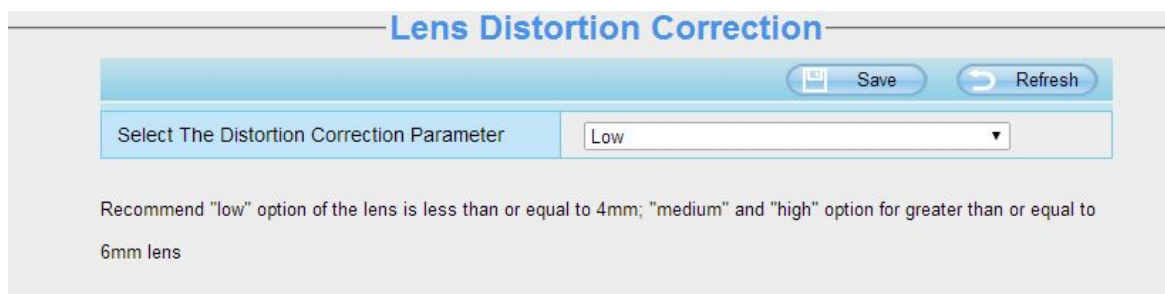

Figure 4.43

## 4.4.6 Lens Distortion Correction

On this page you can set the distortion correction. There are three options: Low, Medium, High.



If you replace the lens, the image has found distortion, uneven and so on, you can modify the **Select The Distortion Correction Parameter** to calibration images.

## 4.5 Alarm

### Motion Detection

IP Camera supports **Motion Detection Alarm**, when the motion has been detected, it will send emails or upload images to FTP.

**Motion Detection**

Save Refresh

Enable

Sensitivity	Medium
Triggered Interval	10s
Action	PC Sound <input type="checkbox"/>
	Send E-mail <input type="checkbox"/>
	Take Snapshot <input type="checkbox"/> Time Interval 2s
Please set the capture storage location in advance.	
<a href="#">Set Detection Area</a>	

Schedule

All	00	01	02	03	04	05	06	07	08	09	10	11	12	13	14	15	16	17	18	19	20	21	22	23
MON																								
TUE																								
WED																								
THU																								
---																								

Figure 4.44

To enable motion detection, follow the steps below:

#### 1 Enable Motion detection

**2 Sensitivity**---- It supports three modes: Low, Middle and High. The higher the sensitivity, the camera will be more easily alarmed. Select one motion sensitivity.

**3 Trigger interval**--- The interval time between two motion detections. Here supports 5s/6s/7s/8s/9s/10s/11s/12s/13s/14s/15s. Select one interval time.

#### 4 There are some alarm indicators:

##### A PC Sound

If you select PC Sound, when the motion has been detected, the people around the PC will hear beep alarm sound.

##### B Send E-mail

If you want to receive alarm emails when motion is detected, you must select Send E-mail and set Mail Settings first.

### C Take Snapshot

If you select this checkbox, when the motion has been detected, the camera will snap the live view window as a still picture and load it.

**Time interval:** The interval time between two pictures.

### 5 Set detect area

Click set detect area and it pop up a window, then you can draw the detection area. Click Back button after settings. When something moving in the detection area, the camera will alarm.

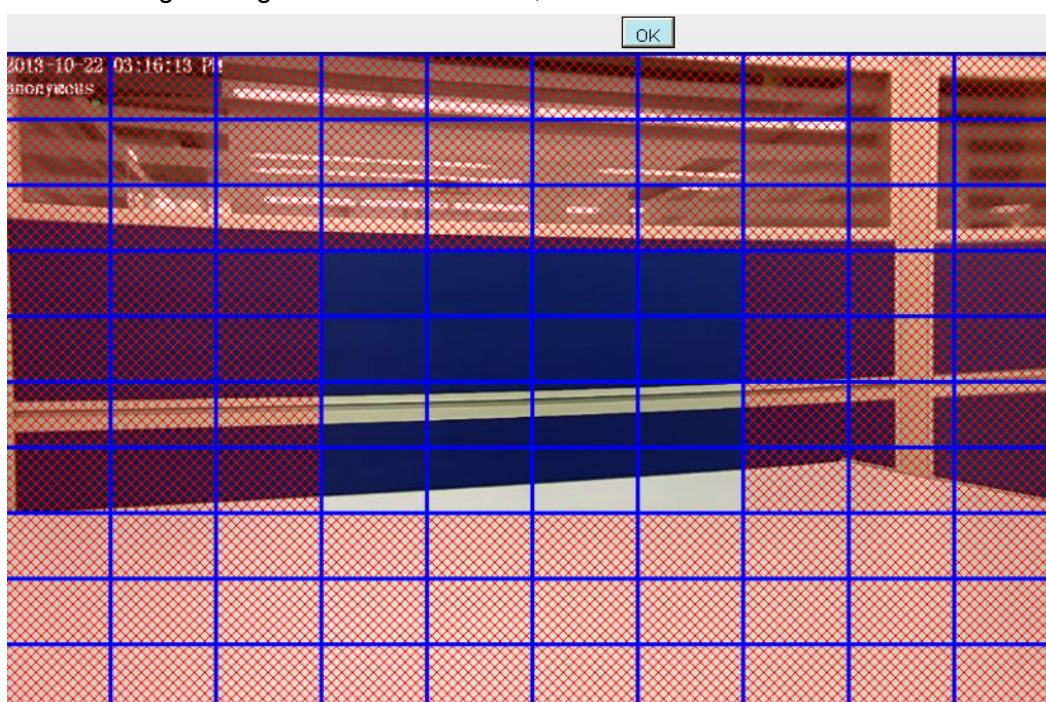

Figure 4.45

### 6 Alarm Schedule

- ① Alarm anytime when motion is detected

Click the black button up the MON, you will see all time range turn red. When something moving in the detection area at anytime, the camera will alarm.



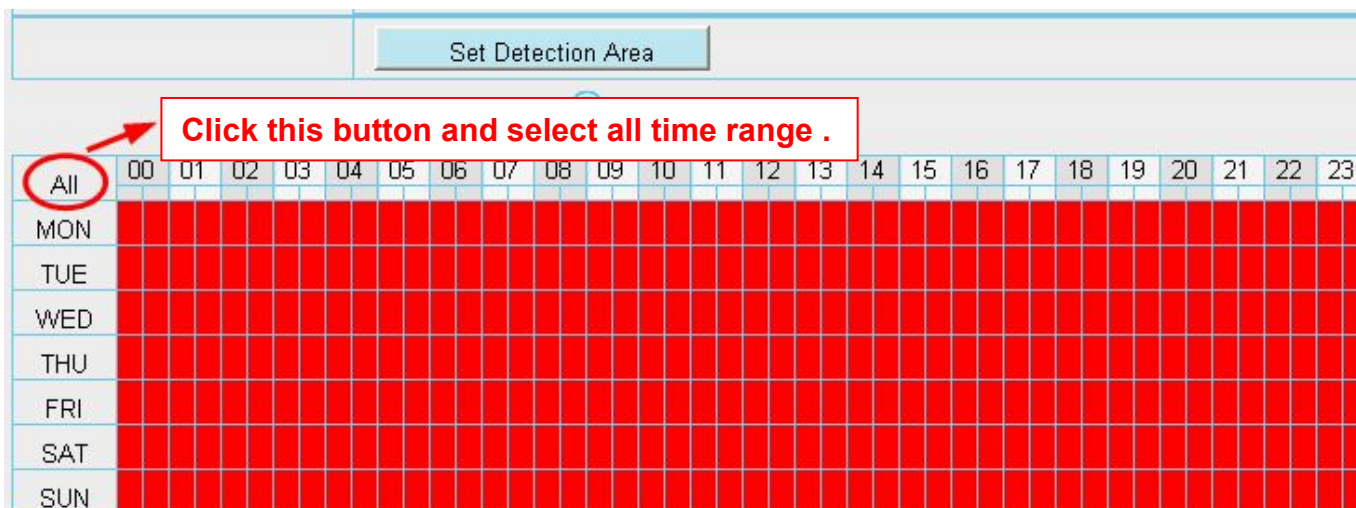

Figure 4.46

② Specify an alarm schedule

Click the week day words, the corresponding column will be selected. For example, click TUE, the all column of TUE turns to red, that means during Tuesday whole day, when something moving in the detection area, the camera will alarm.

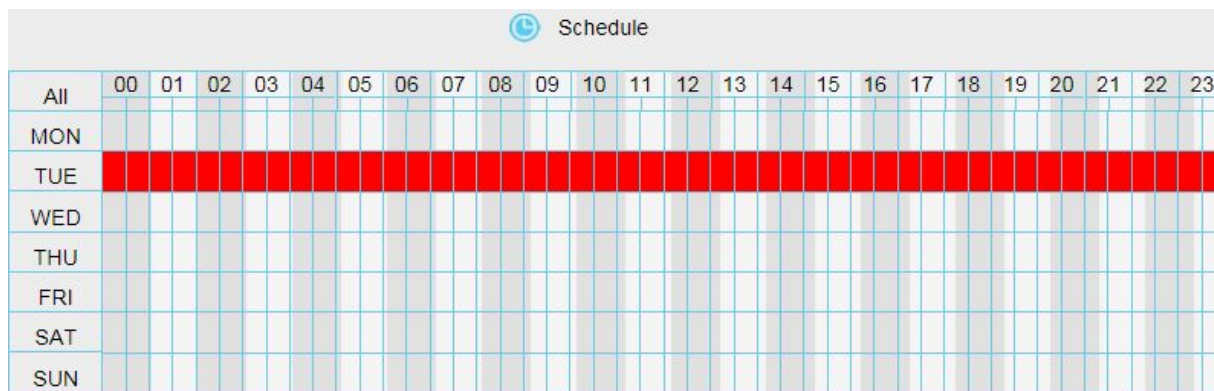
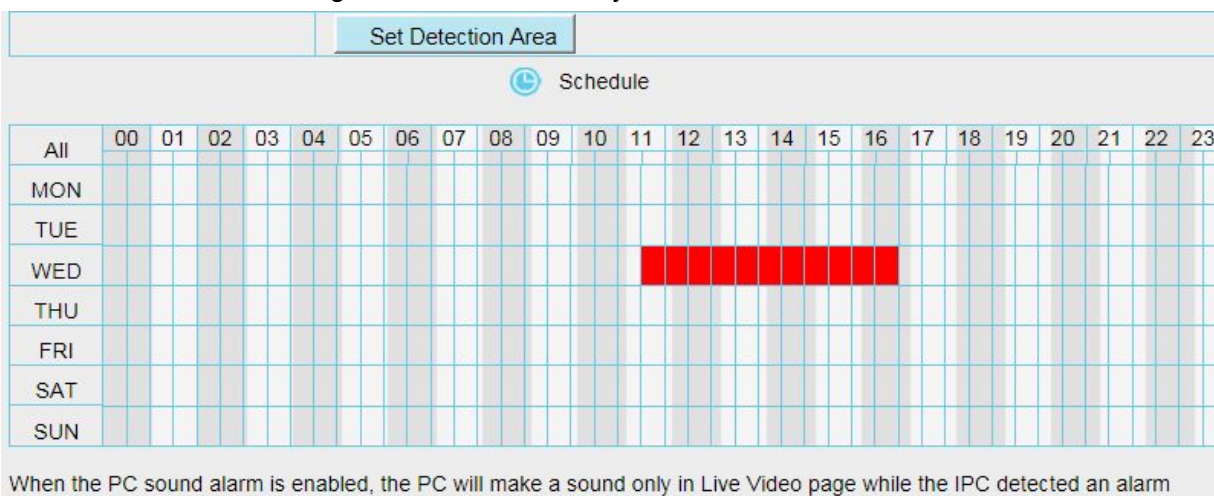

Figure 4.47

③ Press the left mouse and drag it on the time boxes, you can select the serial area,



When the PC sound alarm is enabled, the PC will make a sound only in Live Video page while the IPC detected an alarm

Figure 4.48

**7 Click Save** button to take effect. When the motion is detected during the detection time in the detection area, the camera will alarm and adopt the corresponding alarm indicators.

**NOTE:** You must set the detection area and detection schedule, or else there is no alarm anywhere and anytime.

## 4.6 Record

### 4.6.1 Storage Location

**Storage Location**

Save Refresh

Local Recording Location: c:\IPCamRecord Browse

The local recording must be stored in local storage. The default Windows storage location is "c:\IPCamRecord". The default Mac OS storage location is "/IPCamRecord". If you modify the path on other cameras, this default storage location will be modified accordingly.

Figure 4.49

### 4.6.2 Local Alarm Location

On this page you can enable local alarm record, and select the local alarm record time.

**Local Alarm Recording**

Save Refresh

Enable Local Alarm Recording:

Local Alarm Recording Time: 30s

Figure 4.50

## 4.7 Firewall

This section explains how to control the access permission by checking the client PC's IP addresses. It is composed of the following columns: **Block access from these IP addresses** and **Only allow access from these IP addresses**.

**IP Filtering**

Save Refresh

Enable Firewall

IP Filtering: Block access from these IP addresses (selected), Block access from these IP addresses, Only allow access from these IP addresses

IP Address #1	<input type="text"/>
IP Address #2	<input type="text"/>
IP Address #3	<input type="text"/>
IP Address #4	<input type="text"/>
IP Address #5	<input type="text"/>
IP Address #6	<input type="text"/>
IP Address #7	<input type="text"/>
IP Address #8	<input type="text"/>

Figure 4.51

Enable firewall, If you select Only allow access from these IP addresses and fill in 8 IP addresses at most, only those clients whose IP addresses listed in the Only allow access from these IP addresses can access the Network Camera. If you select Block access from these IP addresses, only those clients whose IP addresses are in the IP list cannot access the Network Camera.

Click Save to take effect.

## 4.8 System

In this panel, you can back up/restore your camera settings, upgrade the firmware to the latest version, restore the camera to default settings and reboot the device.

### 4.8.1 Back-up& Restore

Click Backup to save all the parameters you have set. These parameters will be stored in a bin file for future use.

Click Browse and select the parameters file you have stored, then click Submit to restore the restore the parameters.

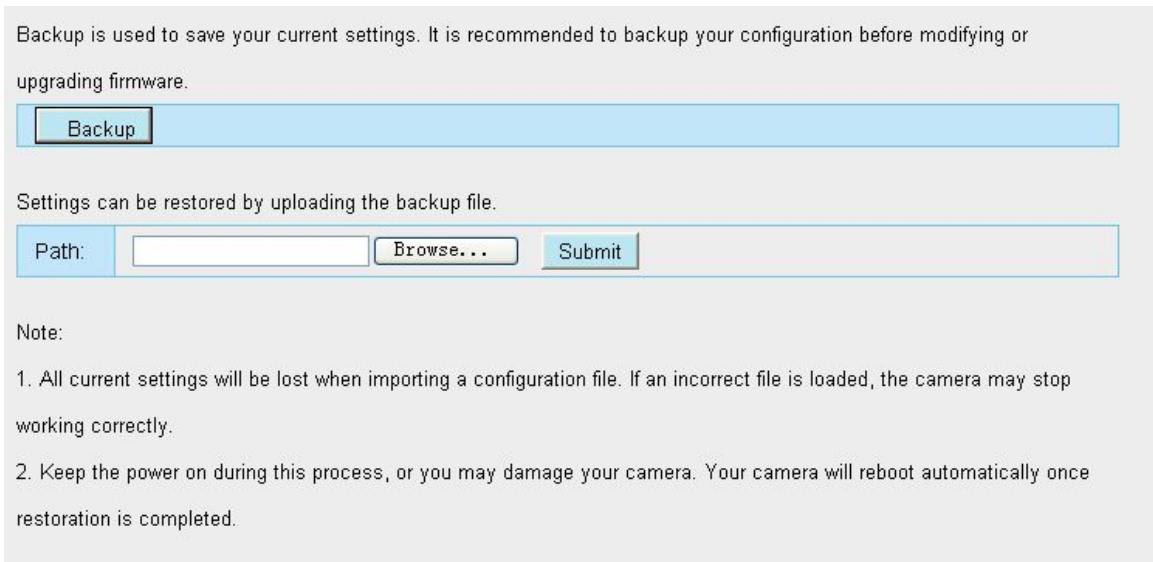

Figure 4.52

## 4.8.2 System Upgrade

Click "Download the latest firmware", you will see the following screen. And click "save" to save the firmware on your computer locally.

Your current firmware version will be displayed on your screen. You may go to the **Status** → **Device Information** page to check for the latest firmware versions available.

Click **Browse**, choose the correct bin file and then click **System upgrade**.

Don't shut down the power during upgrading. After upgrading, you can see the upgrade result.

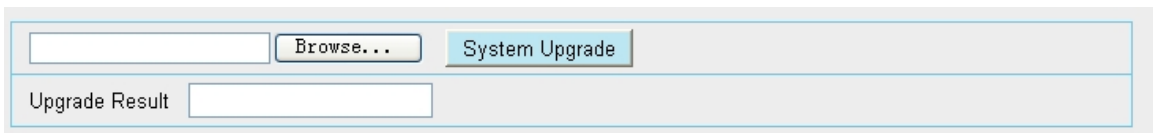



Figure 4.53

## Upgrade Firmware by Equipment Search Tool

Double click the Equipment Search Tool shot icon  , select the Camera IP that you want to upgrade the firmware. Then select Upgrade Firmware and enter the username and password, choose the firmware file, and upgrade.

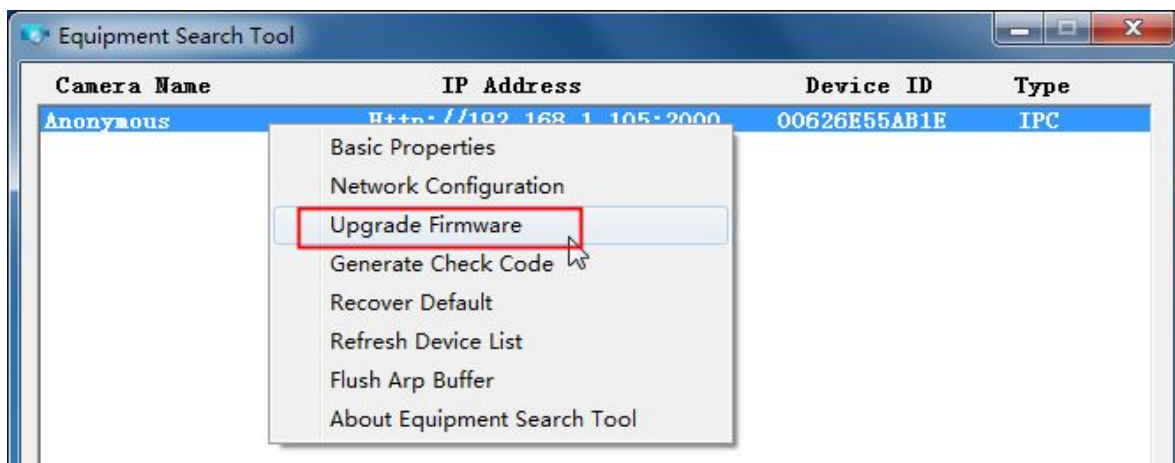

Figure 4.54

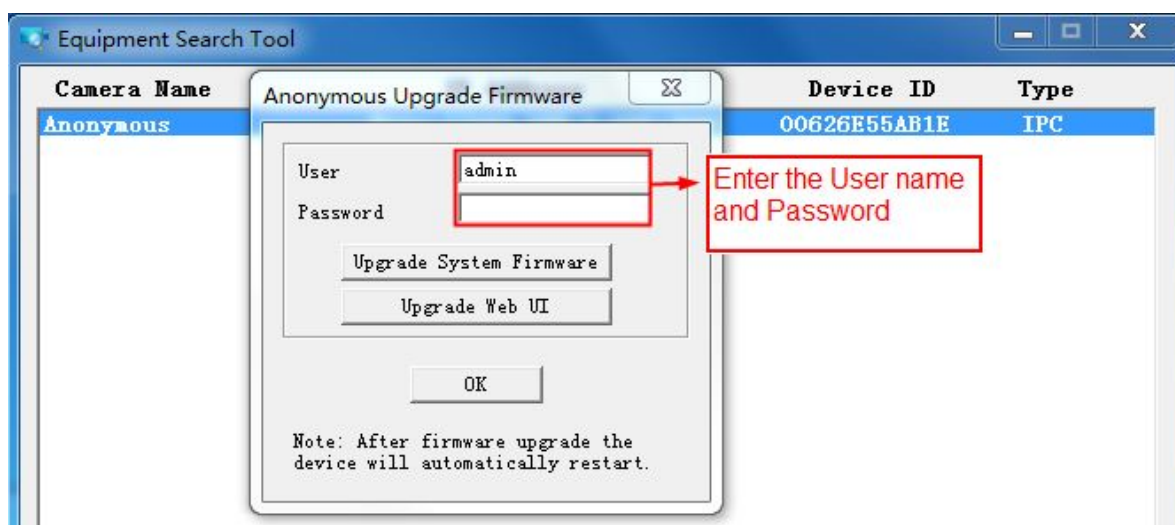

Figure 4.55

**CAUTION:**

If your camera works well with the current firmware, we recommend not upgrading. Please don't upgrade the firmware unnecessarily. Your camera may be damaged if mis-configured during an upgrade.

**NOTE:**

- 1) Don't upgrade the firmware through the web UI in WAN, or else the upgrade may be failed.
- 2) Please ensure you have download the correct firmware package for your camera before upgrading. Read the upgrade documentation (readme.txt file) in the upgrade package before you upgrade.
- 3) Upon downloading the firmware check the sizes of the .bin files. They must match the size in the readme.txt file. If not, please download the firmware again until the sizes are the same. Your camera will not function correctly if a corrupt .bin file is used.
- 4) Normally, only Device WEB UI need to be upgrade, please do not try to upgrade the Device Firmware.
- 5) Never shut down the power of the camera during upgrade until the IP camera restart and get connected.
- 6) After upgrade successfully, please clear the cache of browser, uninstall the old plugin and re-install it, then reset the camera to the default factory settings before using the camera.

### 4.8.3 Factory Reset

Click **Factory Reset** button and all parameters will return to factory settings if selected. The default administrator username is admin with a blank password.

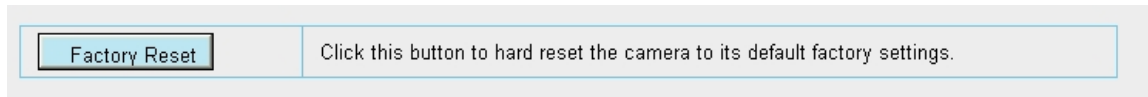

Figure 4.56

### 4.8.4 Reboot

Click **Reboot** to reboot the camera. This is similar to unplugging the power to the camera.

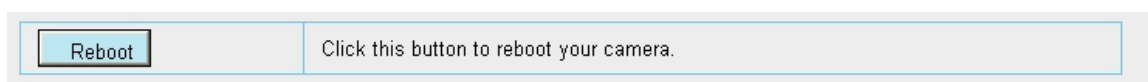

Figure 4.57

## 5 Appendix

### 5.1 Frequently Asked Questions

#### 5.1.1 Install the ActiveX of Firefox browser, Google Chrome and IE Chrome.

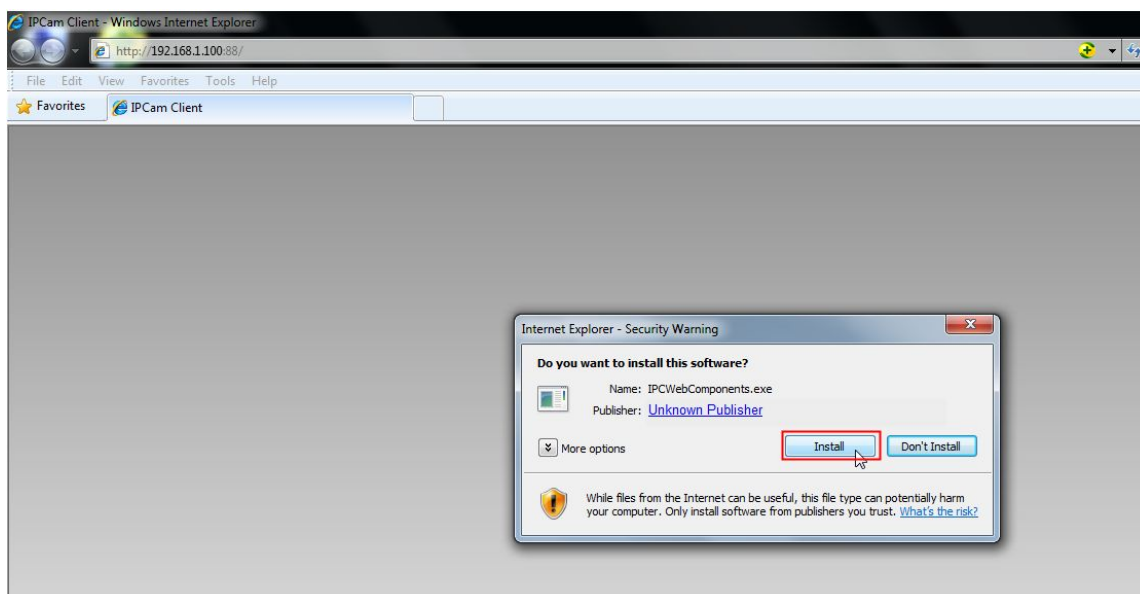

Figure 5.1

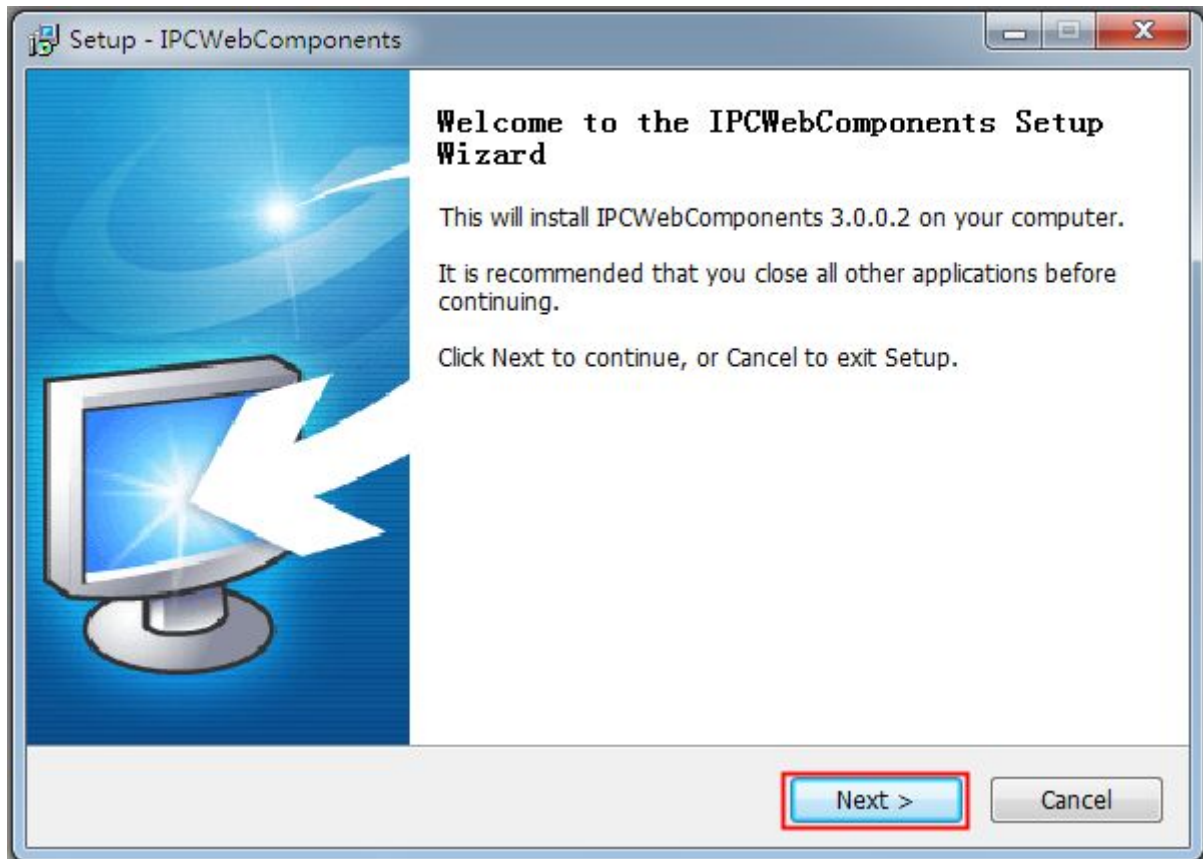

Figure 5.2

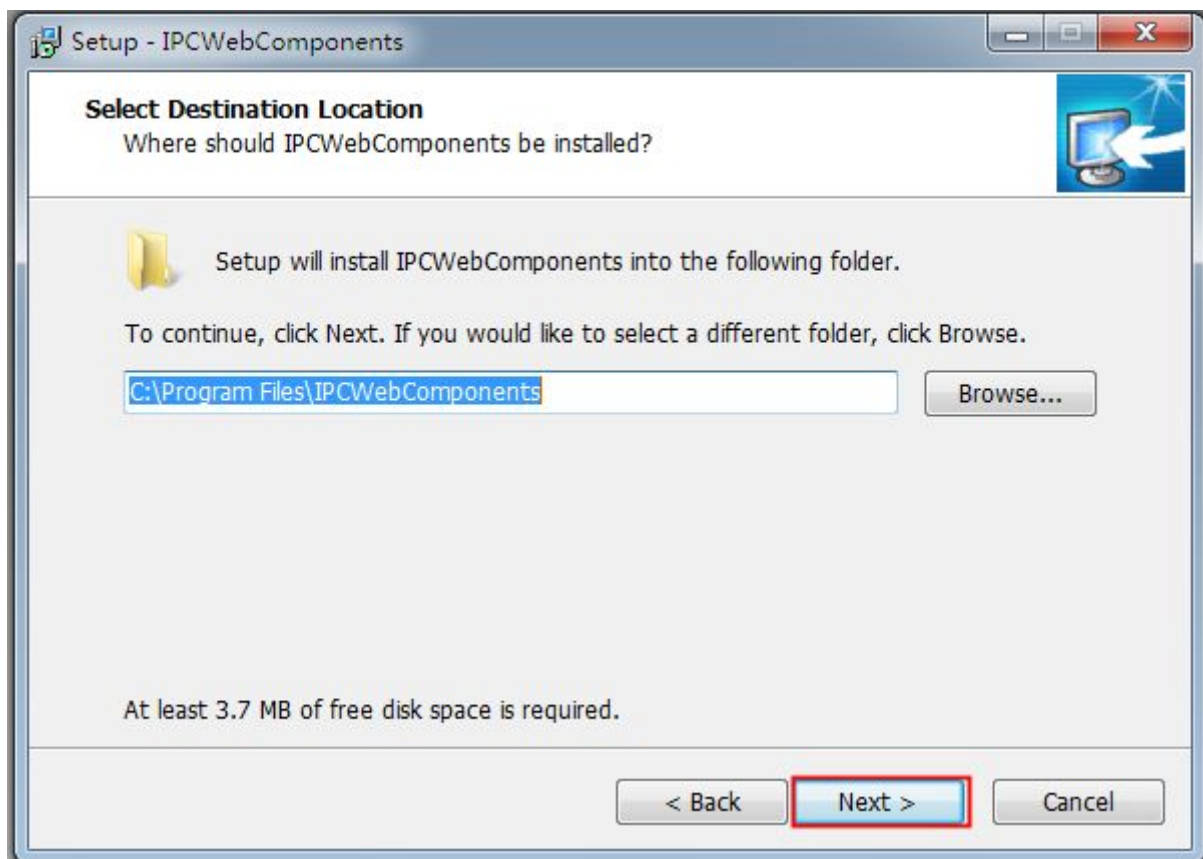

Figure 5,3

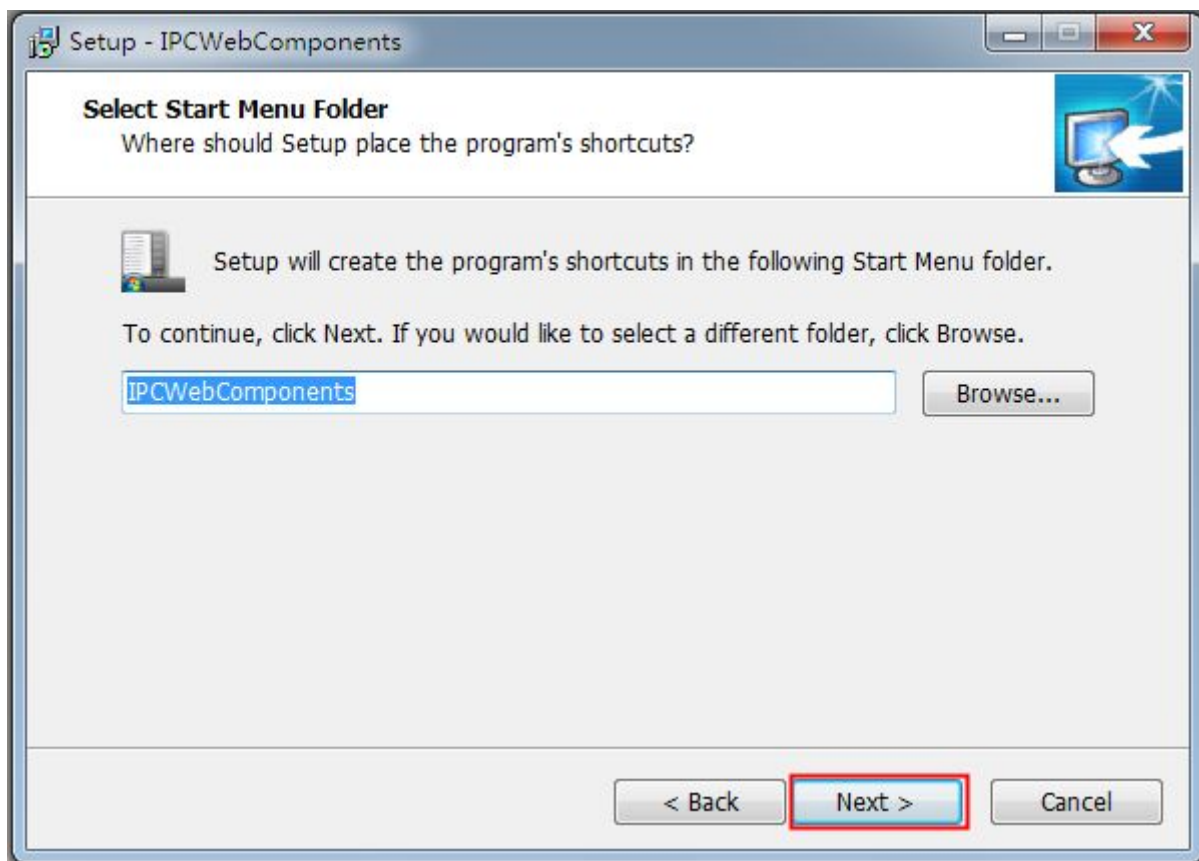

Figure 5.4

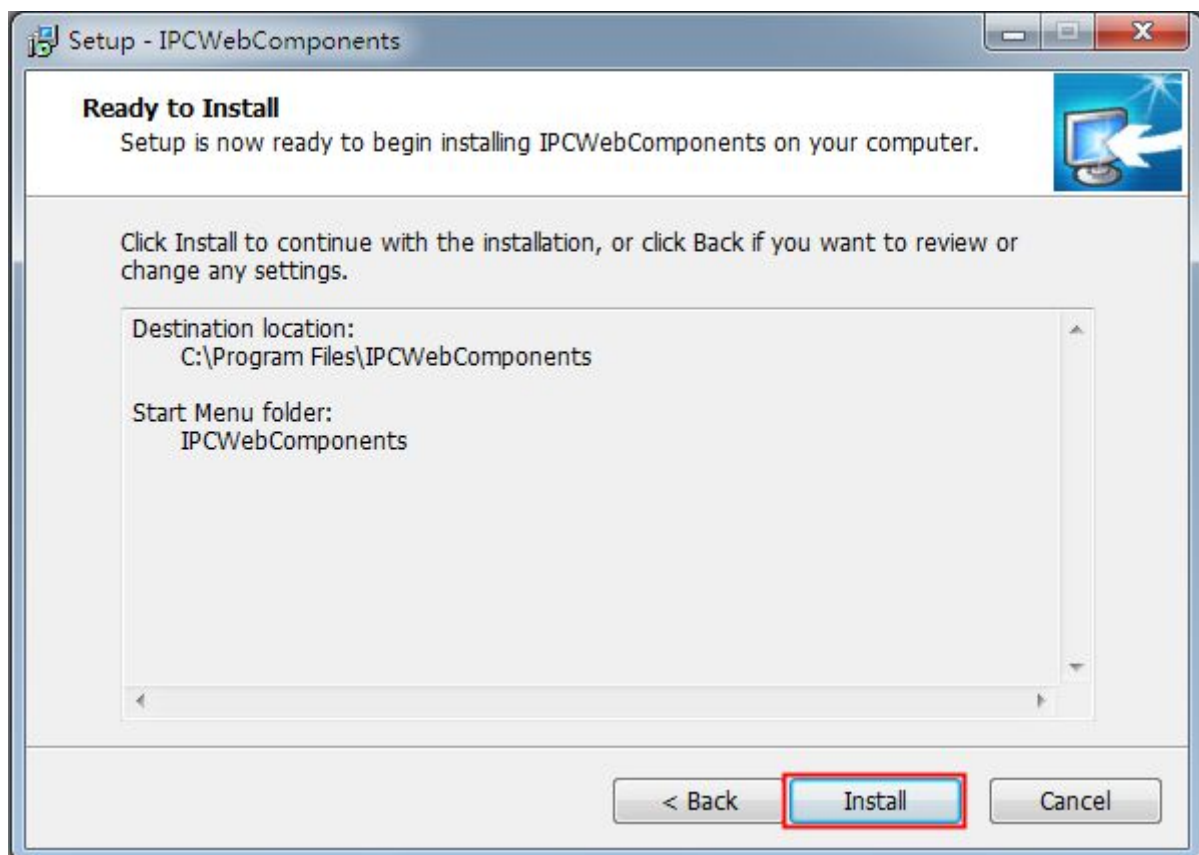

Figure 5.5



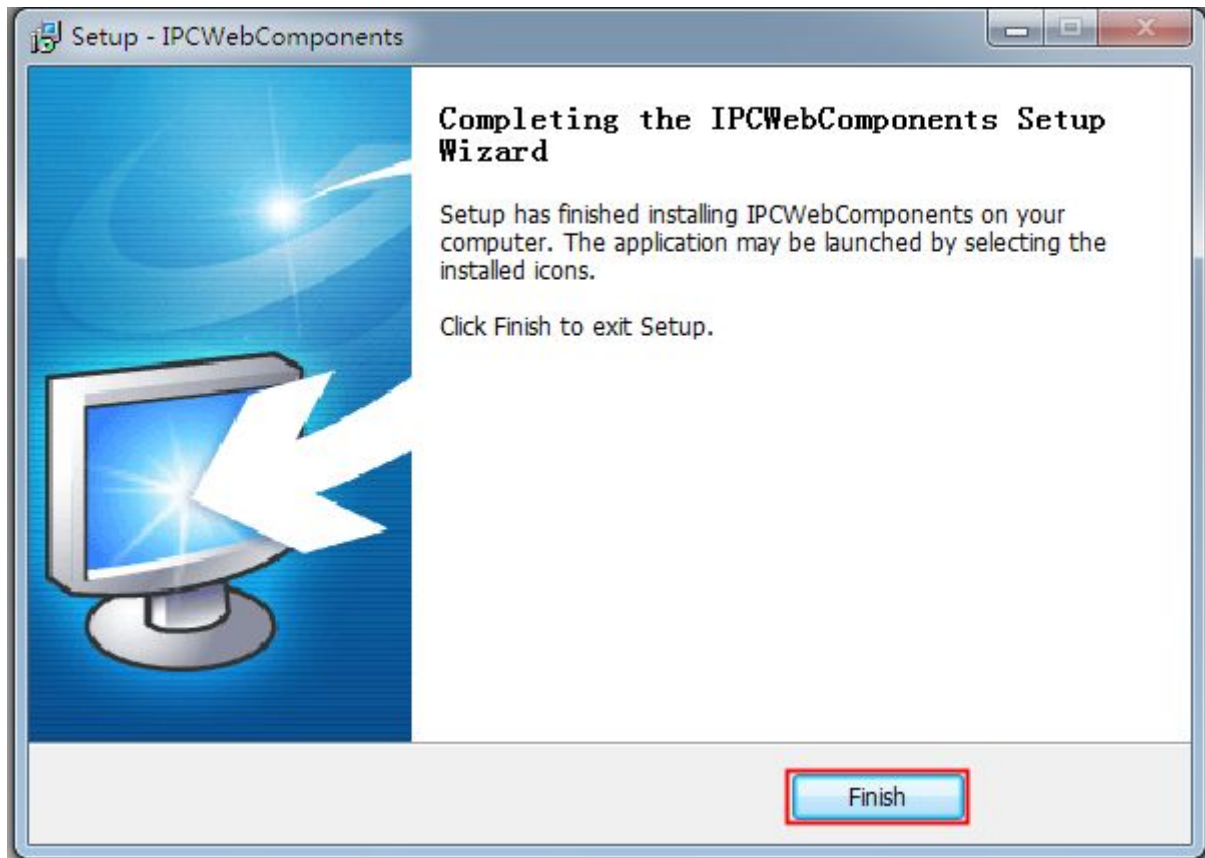

Figure 5.6

### 5.1.2 Uninstall the ActiveX of Firefox browser, Google Chrome and IE Chrome.

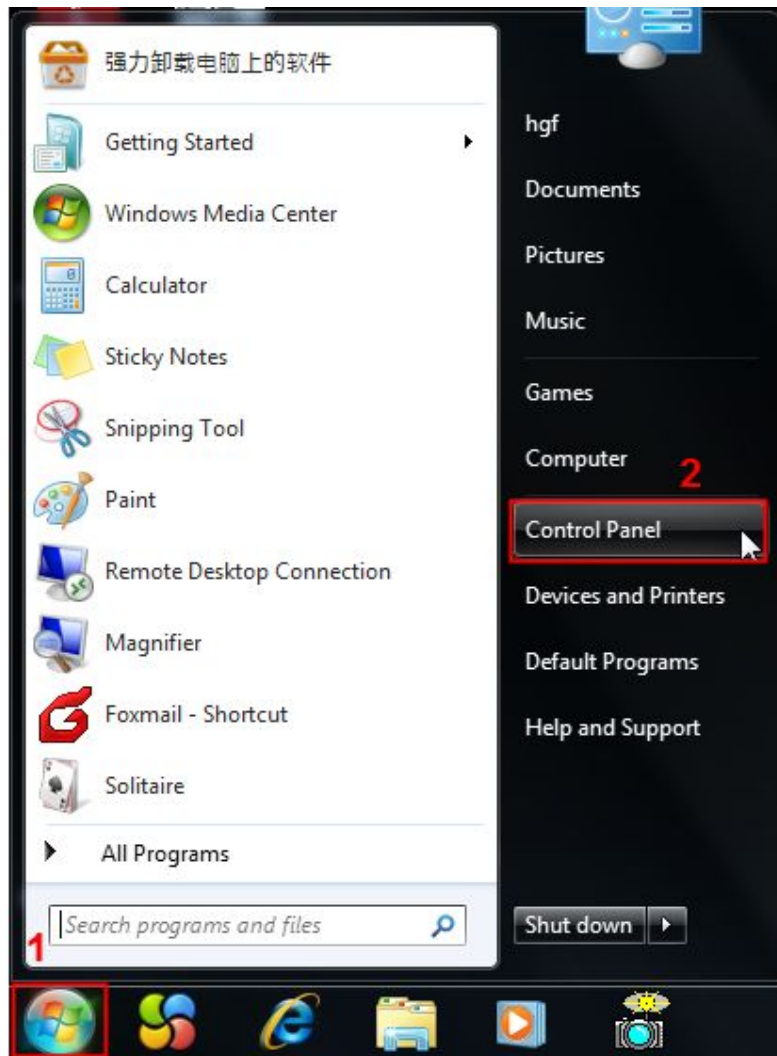

Figure 5.7

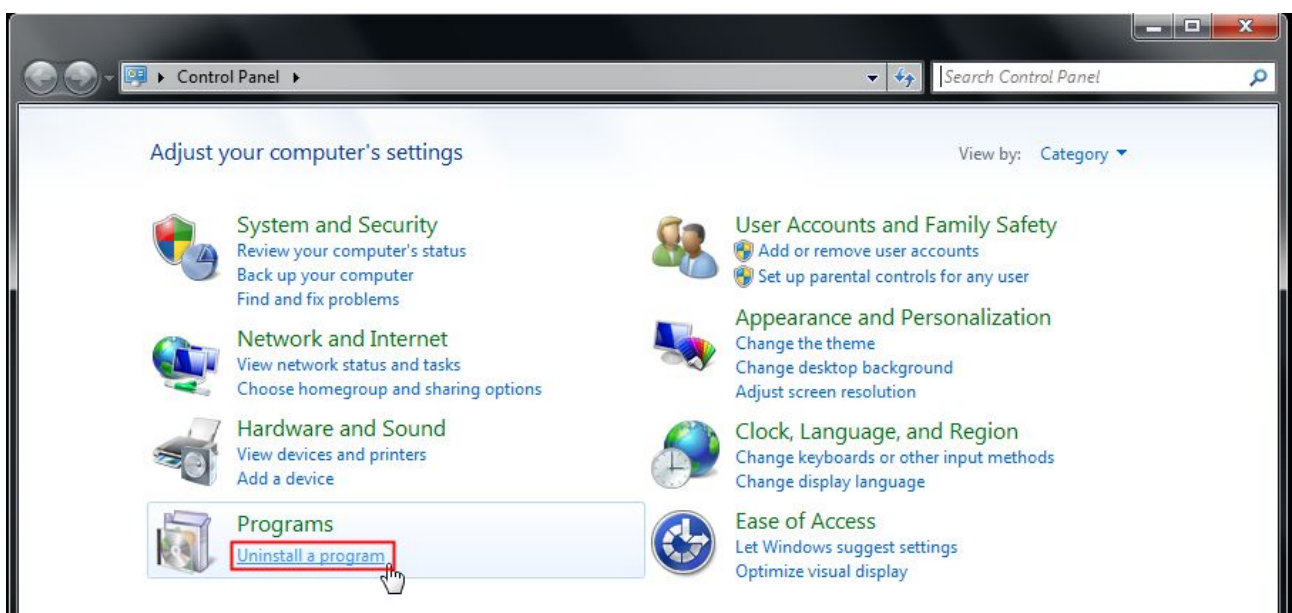

Figure 5.8

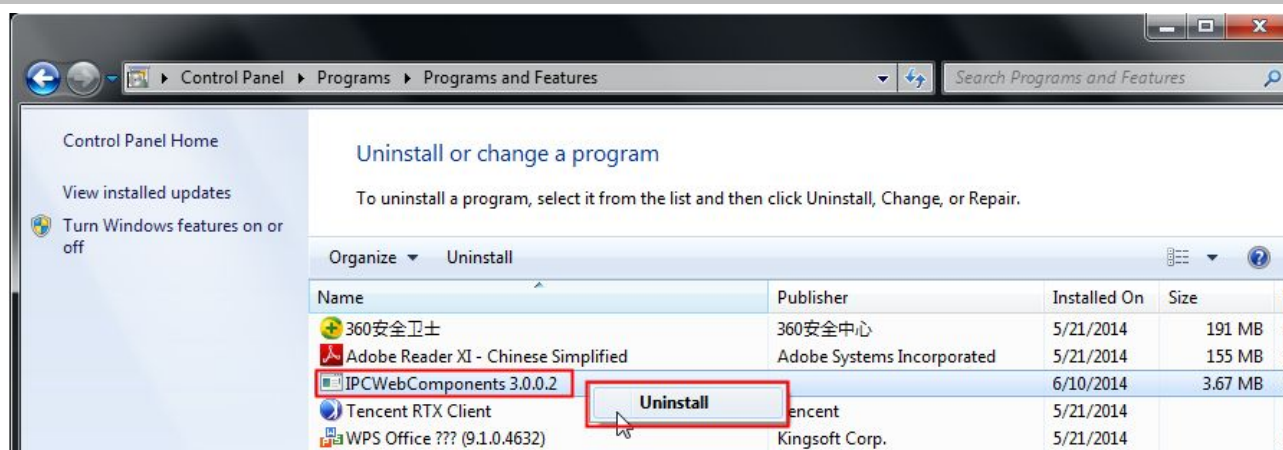

Figure 5.9

### 5.1.3 I have forgotten the administrator password

To reset the administrator password, you had better unplug the network cable firstly. After that, press and hold down the RESET BUTTON about 5 seconds. Releasing the reset button, the password will turn to the factory default.

Default administrator username/password: **admin with blank password**

### 5.1.4 Subnet doesn't match

Check whether your ip camera in the same subnet of your computer. The step is **Control Panel -- Network Connections -- Dbclick Local Area Connections -- Choose General -- Properties**.

Check subnet mask, IP address and gateways. When you set IP address please make sure they are in the same subnet. Otherwise you can't access camera.

### 5.1.5 Camera can not record

Camera can not record when I click Record button or I can't change the manually record path.

When you use Windows7 or Vista, you may be not able to do manually record or change the record path because of the security settings of computer.

There are two ways to resolve this problem:

- 1 Please add the camera as a trusted site to resolve this issue. The steps are IE browser--Tool--Internet Properties--Security--Trusted sites--Sites--Add
- 2 Open IE browser, then right click, select "Run as administrator"

### 5.1.6 No Pictures Problems

The video streaming is transmitted by the ActiveX controller. If ActiveX controller isn't installed correctly you will see no video image. You can resolve this problem by this way:

Download ActiveX controller and set the safety property of IE in the PC when you view it first time: IE

browser--Tool--Internet Proper--Security--Custom Level--ActiveX control and Plug-ins. Three options of front should be set to be “Enable”, The ActiveX programs read by the computer will be stored. As follows:

**Enable: Download unsigned ActiveX controls**

**Enable: Initialize and script ActiveX controls not marked as safe**

**Enable: Run ActiveX controls and plug-ins**

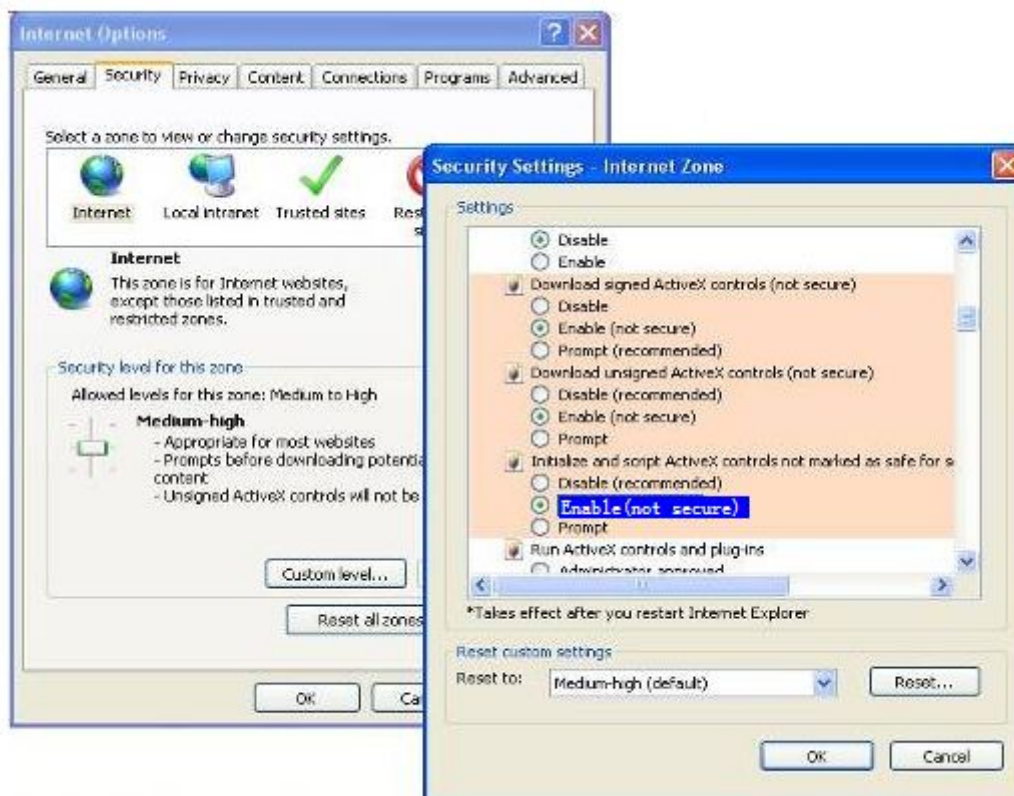

Figure 5.10

If you allow the ActiveX running, but still could not see living video. Please change another port number to try. Don't use port 8000.

		Save	Refresh
HTTP Port	<input type="text" value="88"/>		
Media Port	<input type="text" value="88"/>		
HTTPS Port	<input type="text" value="443"/>		

Figure 5.11

**NOTE:** Make sure that your firewall or anti-virus software does not block the camera or ActiveX. If you could not see video, please shut down firewall or anti-virus software to try again.

### 5.1.7 Can't access IP camera in internet

**There are some reasons:**

- 1 ActiveX controller is not installed correctly
- 2 The port which camera used is blocked by Firewall or Anti-virus software. Please change another port number and try again.

3 Port forwarding is not successful.

Check these settings and make sure they are correct.

## 5.1.8 UPnP always failed

UPnP only contains port forwarding in our recent software. Sometimes, it may be failed to do port forwarding automatically because of firewall or anti-virus software. It also has much relation with router's security settings. So we recommend you do port forwarding manually. You can view your camera in internet successfully after you do port forwarding manually in your router.

## 5.2 Default Parameters

### Default network Parameters

IP address: obtain dynamically

Subnet mask: obtain dynamically

Gateway: obtain dynamically

DDNS: Embedded DDNS Service

### Username and password

Default admin username: admin with a blank password

## 5.3 Specification

ITEMS		
<b>Image Sensor</b>	Sensor	High Definition Color CMOS Sensor
	Display Resolution	1920 x 1080 (2.0M Pixels)
	Min. Illumination	0 Lux (With IR Illuminator)
<b>Lens</b>	Lens Type	Glass Lens
	focal length	f:4mm/6mm/8mm/12mm Option
	Aperture	F1.2
	Angle of View	Horizontal:70° Diagonal :75°
<b>Video</b>	Image Compression	H.264
	Image Frame Rate	30fps(60Hz), 25fps(50Hz), downward adjustable
	Resolution	1080P(1920x1080),720P(1280 x 720), VGA(640 x 480), QVGA(320 x 240)
	Stream	dual stream
	Image adjustment	The hue, brightness, contrast, saturation, sharpness are adjustable
	Flip image	flip and mirror
	Infrared mode	Automatic or manual
	Night visibility	With 2 Infrared Lamp Array, Night Vision Range up to 30m

<b>Network</b>	Ethernet	One 10/100Mbps RJ45 port
	Remote Access	P2P DDNS
	Network Protocol	IP, TCP, UDP, HTTP, HTTPS, SMTP, FTP, DHCP, DDNS, UPnP, RTSP, ONVIF
<b>System Requirements</b>	Operating System	Microsoft Windows 2000/XP, Vista, 7,8; Mac OS
	Browser	Microsoft IE8 and above version or compatible browser; Mozilla Firefox; Google Chrome; Apple Safari.
<b>Other Features</b>	Motion Detection	Alarm via E-Mail, upload alarm snapshot to FTP
	Privacy Block	Set privacy area manually
	User Accounts	Three levels user role
	Firewall	Supports IP Filtering
	Reset	Reset button is available
<b>Physical</b>	Dimension(mm)	153(L)x 92(W)x 86(H)
	Net Weight	380g
	Power Consumption	<14 Watts
<b>Environment</b>	Operating Temperature	-20°C ~ 60°C (-4°F ~ 140°F)
	Operating Humidity	10% ~ 80% non-condensing
	Storage Temperature	-20°C ~ 60°C (-4°F ~ 140°F)
	Storage Humidity	0% ~ 90% non-condensing
<b>Certification</b>	CE, FCC, RoHS	

## 5.4 CE & FCC

### Electromagnetic Compatibility (EMC)

#### FCC Statement



This device complies with FCC Rules Part 15 of the FCC Rules. Operation is subject to the following two conditions.

- This device may not cause harmful interference, and
- This device must accept any interference received, including interference that may cause undesired operation.

This equipment has been tested and found to comply with the limits for a Class A digital device, pursuant to Part 15 of the FCC Rules. These limits are designed to provide reasonable protection against harmful interference when the equipment is operated in a commercial environment. This equipment generates, uses,

and can radiate radio frequency energy and, if not installed and used in accordance with the installation manual, may cause harmful interference to radio communications. Operation of this equipment in a residential area is like to cause harmful interference, in which case the user will be required to correct the interference at his own expense.

**FCC Caution**

Any changes or modification not expressly approved by the party responsible for compliance could void the user's authority to operate this equipment.

This equipment complies with FCC radiation exposure limits set forth for an uncontrolled environment. This equipment should be installed and operated with minimum distance 20cm between the radiator& your body.

This transmitter must not be co-located or operating in conjunction with any other antenna or transmitter.

**CE Mark Warning**



This is a Class A product. In a domestic environment, this product may cause radio interference, in which case the user may be required to take adequate measures.

